



CATÁLOGO
2023

SON NUESTRAS PEQUEÑAS MANOS
LAS QUE CONSEGUIRÁN
GRANDES HITOS.



Tomorrow is
in your hands.



WELCOME

|| ¡Dar a los niños el poder de cambiar el mundo con las manos!
Esa es la misión de nuestra empresa, nuestra brújula, nuestra razón de ser.

Los proyectos son innumerables y, sobre todo, en el terreno medioambiental:

La generalización de la eco-concepción de nuestros productos

El lanzamiento este año de la gama Smiling Planet

O el abandono progresivo de los embalajes plástico en beneficio de los embalajes 100 % reciclables.

En provecho de esta transformación medioambiental acelerada, casi 12 millones de productos Maped muestran el logo de nuestra dotación financiera 1% For Education.

Comprar uno de estos productos implica contribuir a financiar acciones a favor de la educación. **||**

ÍNDICE

DESCUBRA MAPED

2-7 8

COLECCIONES

| | |
|------------------------------|----|
| Smiling Planet | 8 |
| Mini Cute - Edición Limitada | 15 |
| Nightfall - Edición Limitada | 21 |
| Pastel | 28 |

COLOR

30

| | |
|---------------------------|----|
| Gama 1ª Edad | 30 |
| Rotuladores para colorear | 34 |
| Lápices de colores | 41 |
| Gama Escuela | 54 |
| Mini-Artistas | 55 |
| Pintura | 65 |
| Actividades para colorear | 67 |

ESCRITURA

73 166

| | |
|-----------------------------------|-----|
| Glitter | 166 |
| Lápices de grafito y de escritura | 168 |
| Rotuladores de escritura | 179 |
| Bolígrafos | 184 |
| Bolígrafos recargables | 185 |
| Subrayadores | 188 |
| Marcadores permanentes | 193 |

ESCOLAR

195

| | |
|-----------------------|-----|
| Estuches | 73 |
| Sacapuntas | 79 |
| Gomas | 96 |
| Trazado | 108 |
| Compases | 130 |
| Tijeras | 150 |
| Accesorios escolares | 159 |
| Pizarras y accesorios | 159 |

OFICINA / ENMARCADO

245 256

| | |
|-----------------------|-----|
| Office Colours | 195 |
| Grapadoras | 197 |
| Perforadoras | 213 |
| Tijeras de oficina | 221 |
| Cúteres | 228 |
| Cizalla y guillotinas | 231 |
| Lupas | 232 |
| Accesorios de oficina | 234 |
| Artículos de fijación | 236 |
| Corte | 241 |
| Kits | 242 |
| Reglas | 243 |

TRADE MARKETING

| | |
|-----------------|-----|
| Displays vacíos | 245 |
| PLV | 254 |

258

ÍNDICE NUMÉRICO

ÍNDICE ALFABÉTICO



¡Escanea los códigos QR
y descubre nuestros
productos en vídeo!



TOMORROW IS IN YOUR HANDS



Fundada en 1947,
somos **una marca francesa,**
independiente, familiar,
líder mundial en material escolar.



Actualmente, el grupo está formado por:



1430
colaboradores



Presencia en
5 CONTINENTES
Y en más de
120 países



17 FILIALES
EN EL ÁMBITO
INTERNACIONAL



3 CENTROS
DE PRODUCCIÓN
INTEGRADOS



7 MARCAS



161M€
de volumen
de negocios en 2021



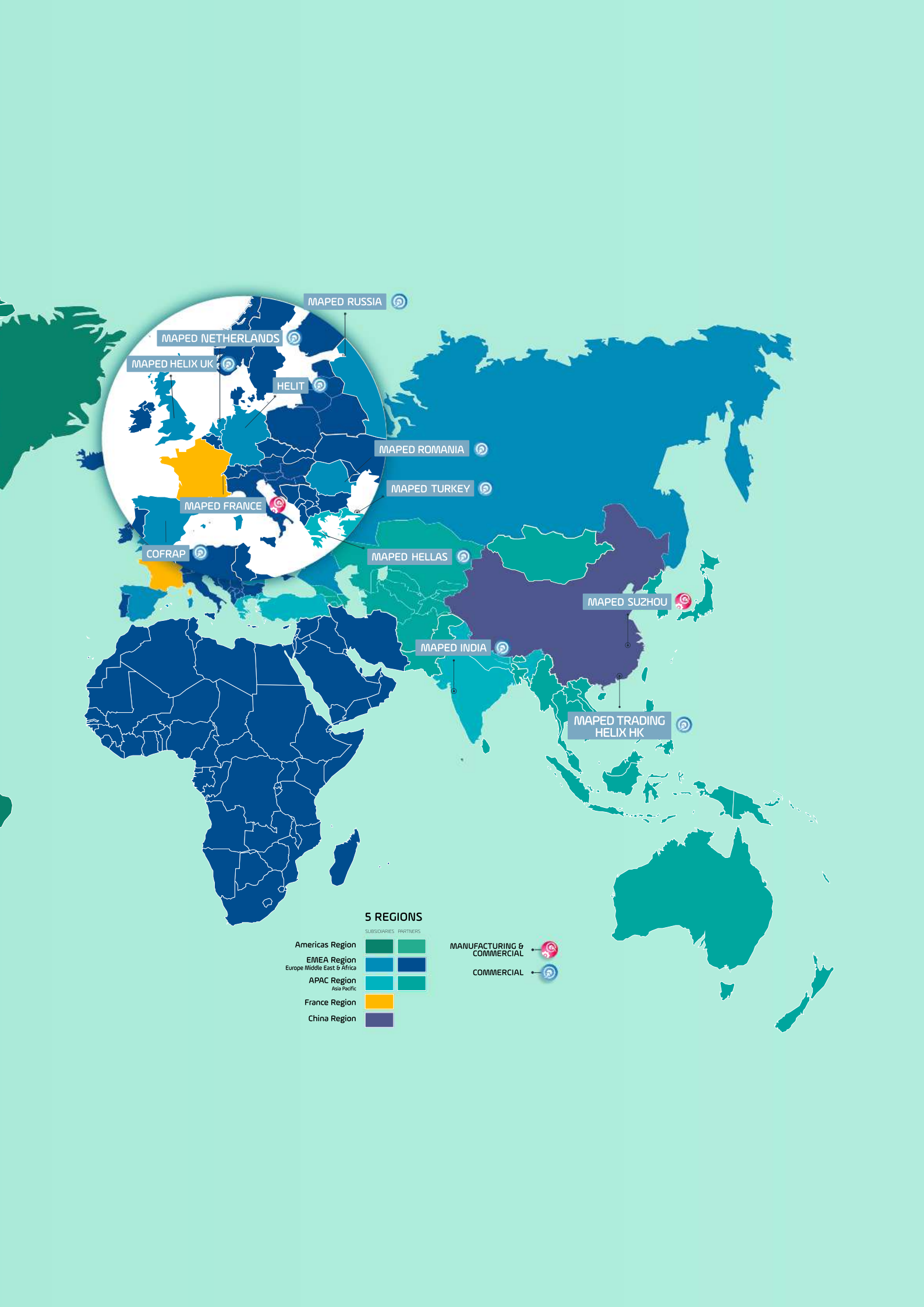

MAPED RUSSIA

MAPED NETHERLANDS

MAPED HELIX UK

HELIT

MAPED ROMANIA

MAPED TURKEY

MAPED FRANCE

COFRAP

MAPED HELLAS

MAPED INDIA

MAPED SUZHOU

MAPED TRADING
HELIX HK

5 REGIONS

| | SUBSIDIARIES | PARTNERS |
|---|--------------|----------|
| Americas Region | | |
| EMEA Region <small>Europe Middle East & Africa</small> | | |
| APAC Region <small>Asia Pacific</small> | | |
| France Region | | |
| China Region | | |

| | |
|----------------------------|--|
| MANUFACTURING & COMMERCIAL | |
| COMMERCIAL | |



CAMBIAR EL MUNDO, BIEN SE MERECE ROMPERSE UN POCO LA CABEZA



PRODUCTOS INNOVADORES
Y UN MONTÓN DE CABEZAS
PARA IMAGINARLOS

¿LA FILOSOFÍA DE NUESTROS PRODUCTOS INNOVADORES?

Se trata de inventar productos **cada vez más ingeniosos y sostenibles** para modificar los usos y brindar a los niños el poder de cambiar el mundo.



En MAPED,
**somos adultos que seguimos
siendo niños** y que trabajamos
codo con codo para dar vida
**a productos cada vez más
ingeniosos.**

MAPED ES COSA SERIA



Una **MARCA REGISTRADA** en más de 130 países



Un catálogo de más de **3500 REFERENCIAS** (alrededor de 60 nuevos productos al año)



100% DE LA CONCEPCIÓN y del diseño de los productos se realiza internamente



MÁS DE 250 diseños y modelos de los productos se realiza internamente



50 PATENTES ACTIVAS



60% de nuestros productos fabricados en **NUESTROS 3 CENTROS** de producción sostenibles y responsables

LA SEGURIDAD ES LO PRIMERO



LABORATORIO DE CALIDAD PROPIO con más de **35 PERSONAS** dedicadas a la calidad



MÁQUINAS DE PRUEBA ÚNICAS



UNA PALABRA CLAVE: ¡EXIGENCIA!





AVANZAR EN EQUIPO Y CON ÉTICA

LA EDUCACIÓN PARA TODOS UN
OBJETIVO DE PRIMERA CATEGORÍA



El 1% del volumen de negocios de los productos vendidos, se dedica a financiar el máximo de iniciativas en favor del acceso y el apoyo a la educación.



En Marruecos

Se han distribuido **cientos** de materiales escolares a los niños desfavorecidos.

En Asia

La red de **Academias Maped** envía material a las escuelas.

En 2019, Maped recibe el premio en calidad de «caring enterprise» por sus donaciones a las escuelas y sus acciones en **las zonas más modestas** de China.



En México

«El mejor estudiante MAPED» apoya la educación y la cultura del país.

En Argentina

«Mano Amiga» ofrece la posibilidad a más de 1000 niños que viven en situación de pobreza extrema **de acceder a la educación.**



NUESTROS COMPROMISOS ÉTICOS

Fabricamos más cerca de nuestros mercados...

Y nuestros mercados son como las escuelas: están en todas partes.

De China a México o de Argentina a Vietnam... ¡son muchas personas!

Puede que seamos niños grandes, pero en MAPED damos prioridad a la salud, la seguridad, la calidad y las condiciones de trabajo dignas.



我是你的彩色
铅笔制造专家*

*Fabrico vuestros lápices
de colores

CHEN HAO



Yo fabrico sus
Contenedores
de Alimentos

EMMA GABRIELA DÍAZ
BERNAL



Je fabrique
vos gommés

*Fabrico vuestras gomas

PHILIPPE LELEUX



SEGÚN LAS ÚLTIMAS NOTICIAS,
SOLO TENEMOS UN PLANETA ASÍ QUE,
MÁS VALE MÁS QUE LO **CUIDEMOS**

REINVENTEMOS NUESTROS PRODUCTOS

El 70% de nuestras emisiones
las generan nuestros productos.

Así que la mejor manera
de cambiar el mañana
es ya diseñarlas mejor.



Gama Geometric

Realizada a base del
80% de material
reciclado y
embalaje de papel
reciclable.



Nuestro compromiso
medioambiental en el punto
de mira de todas
nuestras decisiones:

**REDUCIR EN UNA
TERCERA PARTE
NUESTRA HUELLA
DEL CARBONO DE AQUÍ
AL AÑO 2026.**

para llegar a la neutralidad
del carbono de aquí al 2050.

Sostenible

¡Gracias a la alta
tecnología de
tratamiento de las
hojas, las tijeras
Diamond son
indestructibles!



Materiales certificados FSC



Procedentes de fuentes
gestionadas de forma
sostenible, como
los lápices de colores
y de grafito y las gomas
de borrar.



FSC™ C156374 | www.fsc.org

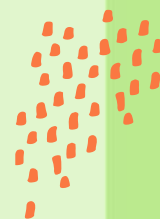

REINVENTEMOS NUESTROS EMBALAJES



ANTES
Cubierta PVC
en las hojas + blíster
de cartón



DESPUÉS
Blíster de cartón
100% reciclable

AHORRO DE
5,5 TONELADAS
DE PVC
EN UN AÑO



¡Embalajes reciclables para un mundo
más sostenible!

¡eliminación del 100% del PVC
de aquí al 2022!

REINVENTEMOS NUESTRA MANERA DE FABRICAR



Menos energía y más verde

Nuestra fábrica en Francia funciona
con electricidad 100% verde,
principalmente de origen hidroeléctrico
desde 2020.

Resultado: ¡un impacto de carbono
dividido por 10 en la electricidad!



Flujos logísticos optimizados

Medios de transporte con
bajas emisiones de carbono y
abastecimiento local.

En Francia, desde principios de 2020,
el 100% de nuestras lanzaderas
entre centros son de biogás.
¡Y esto supone un ahorro del 75%
de emisiones de CO₂!



Protección y reciclaje del agua

En China, en el 2020 se ha instalado
un sistema para reciclar el agua
de la limpieza.

Este sistema permite disponer de un
circuito cerrado «0 residuos» porque
no se vierte agua contaminada.



Dispositivos industriales más sólidos

Por ejemplo, los moldes que
fabrican nuestros rotuladores son
superrobustos y permiten fabricar
centenares de millones de piezas.



WHAT'S ETHIC, KÉSAKO ?

Mi misión es ayudarle a identificar nuestras ofertas más responsables.
Los productos que llevan este pictograma disponen de una o más de las siguientes características:



Son **eco-diseñadas** (productos de material reciclado, embalaje de papel o cartón reciclable, productos fabricados a partir de residuos post-industriales);



Cuentan con **una certificación de que tienen un impacto positivo en el medio ambiente;**



Garantizan que **una parte del volumen de negocios de Maped financia acciones a favor de la educación**

¡Y esto es un gran comienzo para escribir nuestro futuro!
¡No pierda, pues, más tiempo y salga a buscarme!



COLECCIONES

UNICO × ESTILOSO × IMAGINATIVO

Smiling Planet

- ▶ ¡Los productos del mañana se desarrollan hoy!
- ▶ Smiling Planet, una serie nueva esencialmente comprometida con el planeta gracias a un material nuevo compuesto de polvo de madera FSC y materiales reciclados, que reduce la cantidad de plástico en nuestros productos.
- ▶ Porque nuestro futuro es importante, ¡Maped se compromete a reinventar sus productos y embalajes de manera sostenible y responsable!



Estuche Smiling Planet

- Tela 100% reciclada: poliéster
- Cierre de cremallera metálico
- Dimensiones: longitud 220 mm y diámetro 75 mm

ETHIC



ref +/**

936100

-12



3 154149 361007

JUNTOS, HACEMOS UN MUNDO MEJOR.



SMILING
PLANET ♡

¡UNA GAMA ECOLÓGICA Y SOSTENIBLE!

Lápices de colores Smiling Planet

- Lápices de madera con certificación FSC 100% de bosques gestionados de forma responsable
- Cuerpo decorado con extremo pintado
- Mina suave, generoso y resistente: Ø 2.9 mm
- Ergonomía: lápiz triangular para mejorar la sujeción



NEW!



ETHIC

| ref | */** |
|----------|--------------------|
| 831800FC | 12-180 x12 Lápices |



3 154148 318002

Sacapuntas Smiling Planet - 1 Orificio

- Sacapuntas con reserva fabricados con un 50% de fibra de madera con certificación FSC Mix, de bosques gestionados de forma responsable
- Embalaje de cartón reciclable



NEW!

ETHIC

| ref | */** |
|----------|--------|
| 071420FM | 24-288 |



3 154140 714208

| ref | */** |
|----------|--------|
| 071421FM | 28-448 |



3 154140 714215



071420FM



071421FM

Sacapuntas Smiling Planet - 2 Orificios

- Sacapuntas con reserva fabricados con un 50% de fibra de madera con certificación FSC Mix, de bosques gestionados de forma responsable
- Embalaje de cartón reciclable



NEW!

ETHIC

| ref | */** |
|----------|--------|
| 071520FM | 25-250 |



3 154140 715205

| ref | */** |
|----------|--------|
| 071521FM | 25-250 |



3 154140 715212



071520FM



071521FM

Sacapuntas Vivo Smiling Planet - 1 Orificio



- Sacapuntas con reserva fabricados con un 50% de fibra de madera con certificación FSC Mix, de bosques gestionados de forma responsable
- Embalaje de cartón reciclable



NEW!



| ref | */** | | | | |
|----------|---------|----|----|----|------------------|
| 063021FM | 75-3600 | | | | |
| | | 25 | 25 | 25 | |
| | | | | | 3 154 140 630218 |

Goma protegida Smiling Planet



- Funda ergonómica texturizada fabricada con un 50% de fibra de madera con certificación FSC Mix, de bosques gestionados de forma responsable
- Goma de precisión
- Embalaje de cartón reciclable



NEW!



112521FM



112520FM

| ref | */** | | | | |
|----------|--------|----|----|--|------------------|
| 112520FM | 30-360 | | | | |
| | | 15 | 15 | | |
| | | | | | 3 154 141 125201 |
| 112521FM | 30-540 | | | | |
| | | 15 | 15 | | |
| | | | | | 3 154 141 125218 |

Compás Study Smiling Planet - Mina



- Compás mina ergonómica con brazos de metal
- Brazo fabricado con un 50% de fibra de madera con certificación FSC Mix, de bosques gestionados de forma responsable
- Estuche de plástico reciclado con regla integrada



NEW!



| ref | */** | | | | |
|----------|--------|--|--|--|------------------|
| 199591FM | 20-240 | | | | |
| | | | | | 3 154 141 995910 |

Compás Study Smiling Planet Con abrazadera



- Compás con abrazadera ergonómica con brazos de metal
- Brazo y tornillos fabricados con un 50% de fibra de madera con certificación FSC Mix, de bosques gestionados de forma responsable
- Estuche de plástico reciclado con regla integrada



NEW!



| ref | */** | | | | |
|----------|--------|--|--|--|------------------|
| 199121FM | 20-240 | | | | |
| | | | | | 3 154 141 991219 |

Tijeras Vivo Smiling Planet 12 cm

- Aros ergonómicos 3D fabricados con un 50% de fibra de madera con certificación FSC Mix, de bosques gestionados de forma responsable
- Seguridad: cuchillas redondeadas
- Embalaje de cartón reciclable



472020FM



NEW!



472021FM

| ref | */** | | |
|----------|--------|--|------------------|
| 472020FM | 12-144 | | 3 154 144 720205 |
| 472021FM | 20-300 | | 3 154 144 720212 |

Tijeras Vivo Smiling Planet 12 cm - Zurdos

- Aros ergonómicos 3D fabricados con un 50% de fibra de madera con certificación FSC Mix, de bosques gestionados de forma responsable
- Auténticas tijeras para zurdos: cuchillas invertidas
- Seguridad: cuchillas redondeadas
- Embalaje de cartón reciclable



472520FM



NEW!



472521FM

| ref | */** | | |
|----------|--------|--|------------------|
| 472520FM | 12-144 | | 3 154 144 725200 |
| 472521FM | 10-300 | | 3 154 144 725217 |

Tijeras Security Smiling Planet 13 cm

- Aros fabricados con un 50% de fibra de madera con certificación FSC Mix, de bosques gestionados de forma responsable
- Security: un sistema de bloqueo único de las cuchillas para una mayor seguridad
- Embalaje de cartón reciclable



473120FM



NEW!



473121FM

| ref | */** | | |
|----------|--------|--|------------------|
| 473120FM | 12-144 | | 3 154 144 731201 |
| 473121FM | 20-240 | | 3 154 144 731218 |

Tijeras Shape Smiling Planet 16 cm

- Aros fabricados con un 50% de fibra de madera con certificación FSC Mix, de bosques gestionados de forma responsable
- Ergonomía 3D para facilitar la empuñadura
- Embalaje de cartón reciclable



NEW!

| ref | */** | | |
|----------|--------|--|------------------|
| 476020FM | 12-144 | | 3 154 144 760201 |

Tijeras Shape Smiling Planet 16 cm - Zurdos



- Aros fabricados con un 50% de fibra de madera con certificación FSC Mix, de bosques gestionados de forma responsable
- Ergonomía 3D para facilitar la empuñadura
- Embalaje de cartón reciclable



Pizarra Smiling Planet



- Hecho en Francia
- Pizarra 100% cartón
- Barniz resistente
- Borrado en seco
- 1 lado blanco y 1 lado cuadrículado

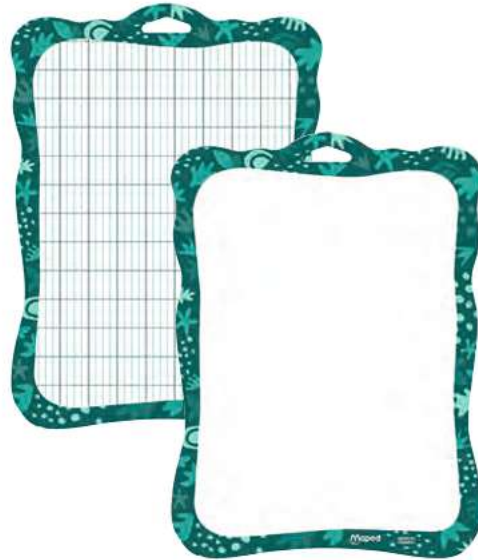

ref 476520FM 12-144

3 154 144 765206

ref 258010 -25

3 154 142 580108

Concept Infantil Smiling Planet - Tupper de alimento de acero inox - 1 l



- *Tapa constituida en un 50% de plástico reciclado
- Base ligera de acero inoxidable de alta calidad
- Estanco



ref 872503 6-12

3 154 148 725039

¡NOSOTROS HAREMOS
DE ESTE MUNDO

UN LUGAR MÁS
TIERNO!



MINI CUTE
¡UNA COLECCIÓN QUE ENAMORA!

Mini Cute - Edición Limitada

- ▶ ¡Divertida, colorida, irresistible, la colección que hace sentir genial a tu estuche!
- ▶ Edición Limitada en 2023



Estuche Mini Cute

- Material de neopreno anti-desgarros, suave al tacto y resistente a los impactos
- Cierre de cremallera metálico
- Dimensiones: longitud 210 mm y diámetro 75 mm



934803



934804

| ref | */** | | |
|--------|------|--|--|
| 934803 | -12 | | |
| 934804 | -12 | | |

Lápices de colores Mini Cute

- Lápices de color de resina
- Ergonomía: lápiz triangular para mejorar la sujeción
- Minas resistentes
- Fáciles de afilar



| ref | */** | | |
|--------|--------|-------------|--|
| 862201 | 12-180 | x12 Lápices | |
| 862203 | 12-72 | x24 Lápices | |



862201



862203

Rotuladores Mini Cute

- Tinta lavable sobre la mayoría de los tejidos
- Punta media bloqueada, ojival, suave y flexible
- Resistentes al secado (duran 1 semana sin tapa)



| ref | */** | | |
|--------|-------|-----------------|---|
| 845404 | 12-96 | x12 Rotuladores |  3 154148 454045 |
| 845406 | 12-48 | x24 Rotuladores |  3 154148 454069 |



845404



845406

Latas Mini Cute - 2 Orificios

- Lata de metal: resistente



044116



044115

| ref | */** | | |
|--------|--------|---|---|
| 044115 | 24-240 |  12 12 |  3 154140 441159 |
| 044116 | 18-468 |  9 9 |  3 154140 441166 |

Loopy Mini Cute





- Dúo de sacapuntas y goma
- Sacapuntas no contaminante
- Goma sin PVC y recargable



049113

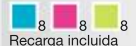

049112

| ref | */** | | |
|--------|--------|--|---|
| 049112 | 24-144 |  8 8 8 Recarga incluida |  3 154140 491123 |
| 049113 | 24-384 |  8 8 8 |  3 154140 491130 |

Goma Pirámide Mini Cute

- Forma triangular con el centro en color



| ref | e/.. | | |
|--------|--------|--|-------------------|
| 119518 | 18-216 | 9 x3 | 3 154 141 195 181 |
| 119519 | 24-576 | 12 x12 Bolsa plástica de protección | 3 154 141 195 198 |



119518



119519

Goma Squeeze Mini Cute

- Efecto apriétame: la primera goma que se presiona para un efecto relajante
- Lúdico: gomas de colores con diseño divertido y atractivo
- Borrado: toda la goma sirve para borrar



| ref | e/.. | | |
|--------|--------|---|-------------------|
| 015501 | 25-300 | 7 6 6 6 | 3 154 140 155 018 |
| 015503 | 25-300 | 1 | 3 154 140 155 032 |
| 015502 | 16-192 | 4 4 4 4 Bolsa plástica de protección | 3 154 140 155 025 |



015501



015503



015502

Regla Twist'n Flex Mini Cute - 30 cm

- ¡"Twist'n Flex The Original" se convierte en una versión aún más divertida!
- Doble graduación



| ref | e/.. | | |
|--------|--------|-------|-------------------|
| 279317 | 25-200 | 30 cm | 3 154 142 793 171 |

Kit de trazado Twist'n Flex Mini Cute - 3 piezas

- ¡"Twist'n Flex The Original" se convierte en una versión aún más divertida!
- 1 regla 15 cm
- 1 cartabón 60°/15 cm
- 1 transportador 180°/10 cm



| ref | e/.. | | |
|--------|--------|----------|-------------------|
| 981828 | 10-200 | 3 piezas | 3 154 149 818 280 |

Compás Kid'z Mini Cute con abrazadera

- Con brazos ergonómicos concebidos para el aprendizaje
- Zona de presión ergonómica
- Punta de seguridad



191612



191613

| ref | */** | | |
|--------|--------|--|--------------------------|
| 191612 | 12-144 | | 6 6 3 154141 916120 |
| 191613 | 24-192 | | 12 12 3 154141 916137 |

Tijeras Mini Cute 13 cm

- Las primeras tijeras decoradas de la hoja a los aros
- Uso escolar: tijeras ergonómicas
- Seguridad: cuchillas redondeadas



464216



464217

| ref | */** | | |
|--------|--------|--|--------------------------|
| 464216 | 12-144 | | 6 6 3 154144 642163 |
| 464217 | 24-360 | | 12 12 3 154144 642170 |

Lápices de grafito Mini Cute - Con goma de borrar

- Una gama de lápices de grafito de resina de gran calidad
- Ergonomía: lápiz triangular para mejorar la sujeción
- Minas resistentes
- Fáciles de afilar



| ref | */** | | |
|--------|---------|--|---------------------------------------|
| 851808 | 24-240 | | x6 3 154148 518082 |
| 851814 | 12-1728 | | x12 - Caja surtida 3 154148 518143 |
| 851874 | -20 | | x72 3 154148 518747 |



851808



851814



851874

Subrayadores Mini Cute

- ¡Formato mini, especial para el estuche!
- Comodidad: punta biselada, trazo de 1 a 5 mm



743677



743638

| ref | */** | | |
|--------|--------|-------------------------|--|
| 743677 | 12-144 | | |
| | | x4 | |
| 743638 | 48-240 | | |
| | | x10 EAN 315414 743634 9 | |
| | | x10 EAN 315414 743635 6 | |
| | | x10 EAN 315414 743633 2 | |
| | | x9 EAN 315414 743636 3 | |
| | | x9 EAN 315414 743630 1 | |

Caja Mini Cute

- Lo mejor de la colección en un estuche de cartón reutilizable
- Para regalar o regalarse a uno mismo
- Contenido: 1 sacapuntas + 1 goma + 1 par de tijeras 13 cm + 2 subrayadores + 6 lápices de colores + cinta adhesiva



| ref | */** | | |
|--------|------|--|--|
| 899789 | -4 | | |



Direction artistique: Zakka. Fotos: Getty.

COLECCIÓN NIGHTFALL



Nightfall - Edición Limitada

- ▶ Vibrante, cautivante, envolvente, la colección que afirma su estilo y atrae los Me gusta
- ▶ Edición Limitada en 2023



Estuche Nightfall

- Cierre de cremallera metálico
- Dimensiones: longitud 210 mm y diámetro 60 mm



| ref | e/.. | | |
|--------|------|--|-----------------|
| 932213 | -12 | | 3 154149 322138 |

Lápices de colores Nightfall

- Lápices de color de madera de calidad
- Cuerpo decorado y metalizado con punta pintada
- Mina suave, generoso y resistente: Ø 2.9 mm
- Ergonomía: lápiz triangular para mejorar la sujeción
- Fáciles de afilar



831700

| ref | e/.. | | |
|--------|--------|-------------|-----------------|
| 831700 | 12-180 | x12 Lápices | 3 154148 317005 |
| 831702 | 12-72 | x24 Lápices | 3 154148 317029 |



831702



Rotuladores Nightfall

- Dos rotuladores de precisión perfectos para escribir, coger notas y colorear
- Tinta lavable sobre la mayoría de los tejidos
- Punta media de poliéster de calidad: \varnothing 0.8 mm, suave, resistente y bloqueada
- Rotuladores de larga duración
- Comodidad: agarre triangular para una sujeción óptima en la mano



844400



844402

| ref | */** | |
|--------|-------|-----------------|
| 844400 | 12-96 | x12 Rotuladores |
| 844402 | 12-48 | x24 Rotuladores |



3 154148 444008



3 154148 444022

Mini Latas Nightfall - 1 Orificio

- Mini lata de metal: resistente e ideal para el estuche



046015



046017

| ref | */** | | |
|--------|--------|--|--|
| 046015 | 20-240 | | |
| 046017 | 18-468 | | |

Goma Nightfall

- Función Dust Free: menos residuo como una goma sin esta función
- Ancho 21.8 mm, profundidad 12 mm, altura 61 mm



116114



116115

| ref | */** | | |
|--------|--------|--|--|
| 116114 | 30-360 | | |
| 116115 | 20-480 | | |

Kit de trazado Nightfall - 4 Piezas

- 1 regla 30 cm
- 1 cartabón 60°/21 cm + 1 escuadra 45°/21 cm
- 1 transportador 180°/12 cm

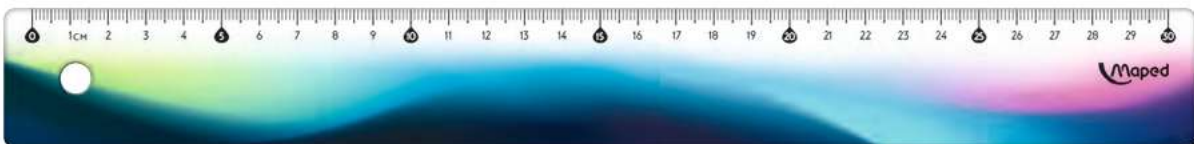
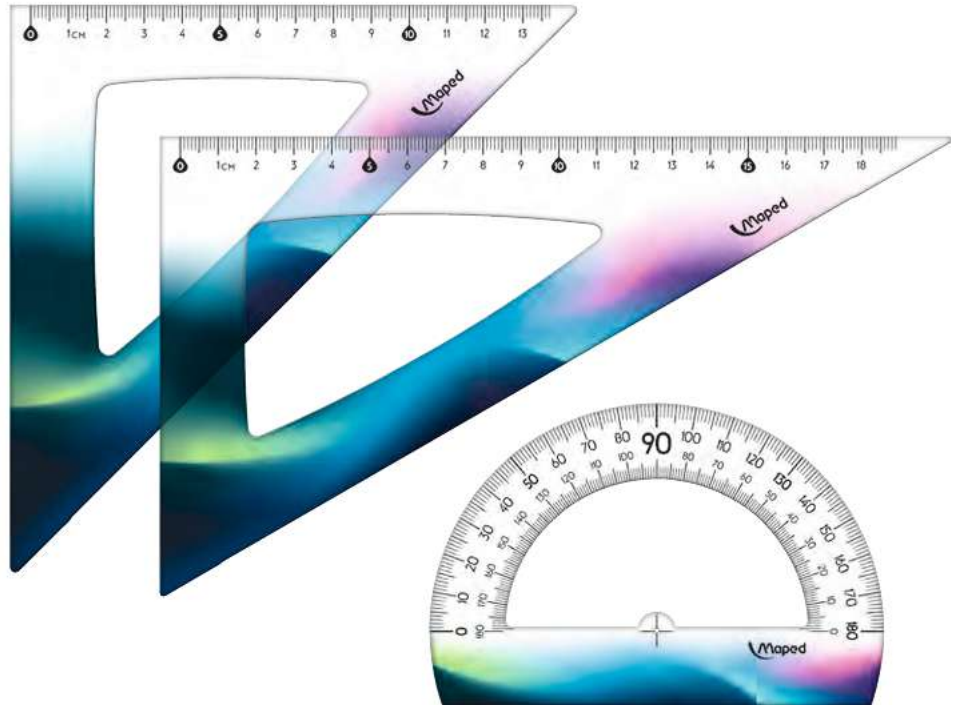
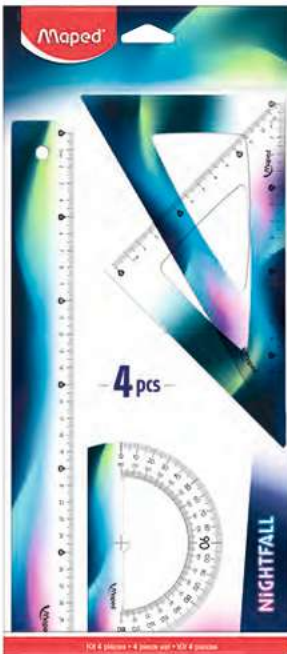

| ref | */** | | |
|--------|--------|--|--|
| 981831 | 24-144 | | |

Regla Nightfall - 30 cm

- Marcado de gran calidad
- Transparente bajo la graduación



| ref | */** | | |
|--------|--------|--|-------|
| 245011 | 25-200 | | 30 cm |



Regla plegable Nightfall

- Facilidad de almacenaje: ideal para el estuche
- Trazo continuo perfecto

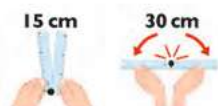

| ref | */** | | |
|--------|--------|--|-------|
| 281018 | 18-360 | | 30 cm |



Mathset Nightfall - 9 Piezas

- Caja de metal colorida
- Compás con brazos de metal decorados



| ref | */** | | |
|--------|-------|--|--|
| 193115 | 12-72 | | 1 compás con abrazadera + 1 compás con mina + 1 sacapuntas + 1 goma + 1 lápiz + 1 regla + 2 escuadras + 1 transportador + 1 caja de metal colorida |



Tijeras Nightfall 16 cm

- Durabilidad óptima de los dibujos
- Confort: material blando en el interior de los aros de los aros



466916



466917

| ref | */** | | |
|--------|--------|--|--|
| 466916 | 12-144 | | |
| 466917 | 12-228 | | |

Tijeras Nightfall 21 cm

- Durabilidad óptima de los dibujos
- Confort: material blando en el interior de los aros



| ref | */** | | |
|--------|--------|--|--|
| 469216 | 12-144 | | |

Lápices de grafito Nightfall - Con goma de borrar

- Una gama de lápices de grafito de resina de gran calidad
- Cuerpos decorados y metalizados
- Minas resistentes
- Fáciles de afilar



851807



851813



851873

| ref | */** | | |
|--------|---------|--|--|
| 851807 | 24-240 | | |
| 851813 | 12-1728 | | |
| 851873 | -20 | | |

Twin Tip 4 Nightfall

- **Innovación:** ¡El primer bolígrafo de 4 colores con 2 puntas!
- **Doble punta para usardos coloreados** mismo tiempo
- **Punta media 1 mm**
- **Fiabilidad:** escritura suave y regular
- **Confort:** doble sujeción suave hasta la punta, para un empuñadura estable y con un confort óptimo



| ref | */** | | |
|--------|--------|--|---|
| 229445 | 12-144 |  x1 |  3 154142 294456 |

Bolígrafos recargables Nightfall

- **Práctico:** recargable con cartuchos estándares
- **Borrable:** con un borrar-reescribir
- **Escritura ultra suave y regular**
- **Calidad de escritura:** pluma de acero con punta de iridio que garantiza un deslizamiento excelente y una escritura regular



| ref | */** | | |
|--------|--------|---|---|
| 220002 | 20-240 |  x1 |  3 154142 200020 |

Subrayadores Nightfall

- **Colores vibrantes para resaltar las notas**
- **Comodidad:** punta biselada, trazo de 1-5 mm



| ref | */** | | |
|--------|--------|--|---|
| 740700 | 12-180 |  x4 |  3 154147 407004 |

Mini Grapadora Nightfall 26/6

- **Capacidad de depósito:** 41 grapas 24/6
o 58 grapas 26/6
- **Profundidad de grapado:** 29 mm
- **Función quita-grapas**

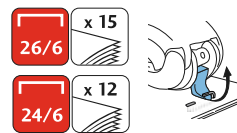

| ref | */** | | |
|--------|--------|---|---|
| 404041 | 24-240 |  Blister + 400 grapas |  3 154144 040419 |

Caja Nightfall

- Lo mejor de la colección en un estuche de cartón reutilizable
- Para regalar o regalarse a uno mismo
- Contenido: 1 sacapuntas + 1 par de tijeras 16 cm + 1 lápiz de graphito + 2 rotuladores + 1 bolígrafo Twin Tip + 5 lápices de colores



| | | |
|--------|------|--|
| ref | */** | |
| 899799 | -4 | |

3 154 148 997993

Botella de acero inox Nightfall - 430 ml

- Colección transversal: Maped y Maped Picnik
- Cuerpo de acero inoxidable de pared interior sencilla
- Sistema automático: apertura con una sola mano y botón de bloqueo
- Estanco



| | | |
|--------|------|--|
| ref | */** | |
| 871299 | 6-12 | |

3 154 148 712992



¿Y SI HACEMOS QUE
LO ORDINARIO SEA REALMENTE
EXTRAORDINARIO?



¡PASTEL,
LA COLECCIÓN IRRESISTIBLE!

DESCUBRE LA COLECCIÓN



ROTULADORES

845469
Pág. 37

LÁPICES

832069
Pág. 49

SACAPUNTAS

VIVO
063011
Pág. 79
GALACTIC
COMFORT
037310
Pág. 92
CONNECT
049230
049231
Pág. 94

DISPLAY

993416
Pág. 95

GOMAS

ZENOA +
123210
123211
Pág. 102
ESSENTIALS
SOFT
112921
Pág. 104
UNIVERSAL
GOM STICK
122010
122011
Pág. 107

COMPASES

STUDY
194510
194111
Pág. 137

TIJERAS

ESSENTIALS
SOFT
464411
Pág. 152
SENSOFT 13 CM
484213
484211
Pág. 154
SENSOFT 16 CM
486214
Pág. 157

LÁPICES DE GRAFITO

GLITTER
851803
851804
851805
Pág. 166
CLASSIC
851719
851730
851769
Pág. 173

SUBRAYADORES

GLITTER
742028 - 742046 - 742038
Pág. 167
CLASSIC
742528 - 742538 - 742546
742558 - 742570 - 742571
742576
Pág. 190

GRAPADORAS

VIVO 26/6 - VIVO N°10
404000 - 404091 - 404002
403000 - 403001
Pág. 197
UNIVERSAL HALF STRIP
UNIVERSAL PINCE 26/6
354301 - 440600
Pág. 204



COLOR

C R E A T I V O × R E S P O N S A B L E × I N C L U S I V O

Early age

- ▶ Una gama dedicada para los chiquitines; identificable a primera vista gracias a su carta gráfica
- ▶ Ideal para dibujar, colorear y pintar con total seguridad
- ▶ Cumple con la normativa de juguetes



Tizas plásticas - Baby crayons

- El primer lápiz del bebé, a partir de 1 año
- Forma redondeada para que el niño pueda sujetarlo bien con la mano
- Diseño lúdico: 8 emociones divertidas dibujadas en las ceras



ref. // **

863806

12-72



x6 Baby crayons



3 154148 638063

Lápices de colores - Jumbo

- Una gama de lápices de varios colores
- Mina amplia : Ø 5 mm, cobertura de una superficie muy amplia
- Mina blanda y resistente
- Diámetro grueso: empuñadura en la mano fácil para los más jóvenes



834010



834012



834013

| ref | e/... | | |
|--------|--------|-------------------|--|
| 834010 | 12-108 | x12 Lápices Jumbo | |
| 834012 | 12-72 | x18 Lápices Jumbo | |
| 834013 | 12-48 | x24 Lápices Jumbo | |

COLOR

Lápices de colores - Jumbo (FSC certificado)



- Lápices de madera con certificación FSC 100% de bosques gestionados de forma responsable
- Embalaje de cartón reciclable
- Mina amplia: Ø 5 mm, cobertura de una superficie muy amplia
- Mina blanda y resistente
- Diámetro grueso: empuñadura en la mano fácil para los más jóvenes
- Disponible solo en Francia



834010FC



834012FC



834013FC

| ref | e/... | | |
|----------|--------|-------------------|--|
| 834010FC | 12-108 | x12 Lápices Jumbo | |
| 834012FC | 12-72 | x18 Lápices Jumbo | |
| 834013FC | 12-48 | x24 Lápices Jumbo | |



Rotuladores - Jumbo

- Rotulador especialmente concebido para los chiquitines, a partir de 1 año
- Punta seguridad: bloqueada en 2 sentidos (no se puede meterse para dentro ni arrancar)
- Tinta ultralavable sobre la mayoría de los tejidos y en la piel con agua y jabón
- Facilitar la sujeción a los más jóvenes
- Punta ancha bloqueada, ojival: Ø 5 mm



846020



846222

| ref | */** | | |
|--------|-------|-----------------------|---|
| 846020 | 12-48 | x12 Rotuladores Jumbo |  3 154148 460206 |
| 846222 | 12-48 | x24 Rotuladores Jumbo |  3 154148 462224 |

Ceras de colores - Wax Jumbo

- Lápices de cera suaves con colores vivos
- Cuerpo bajo funda protectora de papel que no mancha las manos



| ref | */** | | |
|--------|-------|-----------------------|---|
| 861311 | 12-72 | x12 Lápices Wax Jumbo |  3 154148 613114 |



Maletín de coloreado

- Mi primer maletín lleno de productos de coloreado
- Fácil de abrir y cerrar para las manitas
- Fácilmente transportable gracias a la empuñadura
- Contenido: 10 Rotuladores Jumbo + 12 Tizas de coloreado Wax Jumbo + 1 póster gigante (51x33 cm)



| | | | |
|--------|------|---|---|
| ref | */** | | |
| 897416 | -4 | 2 | 2 |



3 154 148 974 161

Pintura con el dedo

- ¡El primer planteamiento lúdico de la pintura!
- Dermatológicamente testado y adaptado a los chiquitines (incluso los menos de 3 años)
- Pintura al agua lista para usar
- Textura untuosa que no se veierte
- Gran poder de cobertura
- 4 colores ultra vivos y brillantes
- Fácil de limpiar pasando las manos debajo del agua



| | | | |
|--------|-------|--------------|--|
| ref | */** | | |
| 812510 | 10-30 | x4 Botes 80g | |



3 154 148 125 105

Bata de protección

- ¡Un indispensable para las primeras actividades creativas!
- Fácil de poner y de cerrar gracias al velcro en la espalda
- Mangas largas elásticas
- Material flexible e impermeable, fácilmente lavable : delante y detrás en PEVA, mangas en poliéster
- Para los niños de 18 meses a 5 años : de 82 a 110 cm



| | | | |
|--------|-------|---------|--|
| ref | */** | | |
| 820310 | 10-60 | x1 Bata | |



3 154 148 203 100

Long Life

- Una gama de rotuladores ultralavables, larga duración
- Cumple con la normativa de juguetes
- Tinta ultralavable sobre la mayoría de los tejidos y en la piel con agua y jabón
- Punta media bloqueada, cónica: Ø 3.6 mm



Long Life Innovation

- Una solución lúdica e inteligente para no perder los capuchones
- Los capuchones están integrados en una base blanda e irrompible
- Compacto: se introducen fácilmente en la mochila
- Innovación patentada



| ref | */** | | |
|--------|-------|-----------------|---|
| 845045 | 12-72 | x12 Rotuladores |  |

Estuches con cremallera de plástico



845017



845015

| ref | */** | | |
|--------|-------|-----------------|---|
| 845017 | 12-96 | x12 Rotuladores |  |
| 845015 | 12-72 | x15 Rotuladores |  |

Estuches

| ref | */** | | |
|--------|-------|-----------------|---|
| 845020 | 12-96 | x12 Rotuladores |  |
| 845021 | 12-72 | x18 Rotuladores |  |
| 845022 | 12-48 | x24 Rotuladores |  |



845020



845021



845022

Estuche para colorear

- Estuche de tela 100% algodón
- Personalizable con rotuladores y lápices
- Súper-práctico: se cierra con velcro
- Contenido: 12 rotuladores Long Life y 12 Lápices Strong



COLOR

| ref | */** | | |
|--------|-------|---|---|
| 984729 | 12-96 | x12 Rotuladores Long Life y 12 Lápices Strong |  |

Jungle

- ▶ Una gama de rotuladores de tinta lavable, ideal para colorear
- ▶ Cumple con la normativa de juguetes
- ▶ Tinta lavable sobre la mayoría de los tejidos
- ▶ Punta media bloqueada, ojival, suave y flexible: Ø 2.8 mm
- ▶ Resistentes al secado (duran 1 semana sin capuchón)



Estuches



845420



845421

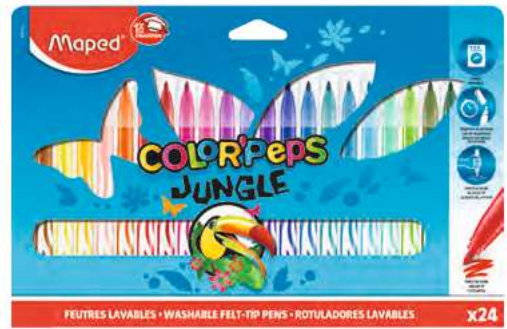

845422

| ref | */** | | |
|--------|-------|--|---|
| 845420 | 12-96 | x12 Rotuladores <i>El 1% del volumen de negocios dedicado a financiar iniciativas en favor del acceso y el apoyo a la educación</i> |  |
| 845421 | 12-72 | x18 Rotuladores |  |
| 845422 | 12-48 | x24 Rotuladores <i>El 1% del volumen de negocios dedicado a financiar iniciativas en favor del acceso y el apoyo a la educación</i> |  |
| 897412 | 12-48 | x12 Rotuladores Jungle + x15 Lápices Bolsa resellable |  |





Estuches promocionales

- La caja viene con etiquetas para poner el nombre del niño
- ¡Ideal para no perder el material en la escuela!



| ref | */** |
|--------|---|
| 845435 | 12-96 x12 Rotuladores + 12 etiquetas gratis |



3 154148 454359

Jungle Innovation

- Una solución lúdica e inteligente para no perder los capuchones
- Los capuchones están integrados en la base blanda
- **Compacto:** se mantienen de pie en posición cerrada y se introducen fácilmente en el estuche o la mochila
- Innovación patentada



| ref | */** |
|--------|---------------------|
| 845445 | -12 x12 Rotuladores |



3 154148 454458

Rotuladores Pastel

- ¡Una paleta de rotuladores suaves y brillantes!



| ref | */** | | |
|--------|--------|-----------------|--|
| 845469 | 12-144 | x10 Rotuladores | |

Rotuladores decorados Monster

- ¡Una gama de rotuladores decorados que encantará a los niños!
- Especificaciones de productos similares a la gama de rotuladores Jungle



845400



845401



984718

| ref | */** | | |
|--------|-------|---|--|
| 845400 | 12-96 | x12 Rotuladores monstruos | |
| 845401 | 12-48 | x24 Rotuladores monstruos | |
| 984718 | 12-48 | x12 Rotuladores monstruos + x15 Lápices monstruos Bolsa resellable | |



Rotuladores decorados Animals

- Especificaciones de productos similares a la gama de rotuladores Jungle



| ref | */** | | |
|--------|-------|--------------------------|--|
| 845403 | 12-96 | x12 Rotuladores animales | |

Ocean

- ▶ Una gama de rotuladores de tinta lavable, ideal para dibujar y colorear
- ▶ Cumple con la normativa de juguetes
- ▶ Tinta lavable sobre la mayoría de los tejidos
- ▶ Punta media bloqueada, ojival, suave y flexible: Ø 2 mm



Bolsas de plástico reutilizables



984701



845723



845724



845720



845721



845722



845725



845726

| ref | */** | | |
|--------|--------|---|-----------------|
| 984701 | 12-48 | x12 Ocean Rotuladores + x15 Lápices Bolsa resellable | 3 154149 847013 |
| 845723 | 12-216 | x6 Rotuladores | 3 154148 457237 |
| 845724 | 12-144 | x10 Rotuladores | 3 154148 457244 |
| 845720 | 12-96 | x12 Rotuladores | 3 154148 457206 |
| 845721 | 12-72 | x18 Rotuladores | 3 154148 457213 |
| 845722 | 12-48 | x24 Rotuladores | 3 154148 457220 |
| 845725 | 12-48 | x36 Rotuladores | 3 154148 457251 |
| 845726 | 12-24 | x48 Rotuladores 48 colores diferentes | 3 154148 457268 |

NEW!



Estuche

- ¡1/2 metro de colores!



| ref | •/•• | | |
|--------|-------|----------------------------------|---|
| 845727 | 12-24 | x48 Rotuladores - Inner decorado |  |

Rotuladores decorados Ocean Life

- Especificaciones de productos similares a la gama de rotuladores Ocean
- El tema del Océano cobra vida en el cuerpo de estos rotuladores



845700



845701



845703



845704

| ref | •/•• | | |
|--------|--------|---|---|
| 845700 | 12-216 | x6 Rotuladores |  |
| 845701 | 12-96 | x12 Rotuladores |  |
| 845703 | 12-48 | x24 Rotuladores |  |
| 845704 | 12-48 | x24 Rotuladores punta fina - Versión Francesa |  |

COLOR'PEPS

infinity

INNOVACIÓN

POR FIN LÁPICES DE COLORES
HASTA EL INFINITO
COMO NUESTRA IMAGINACIÓN.

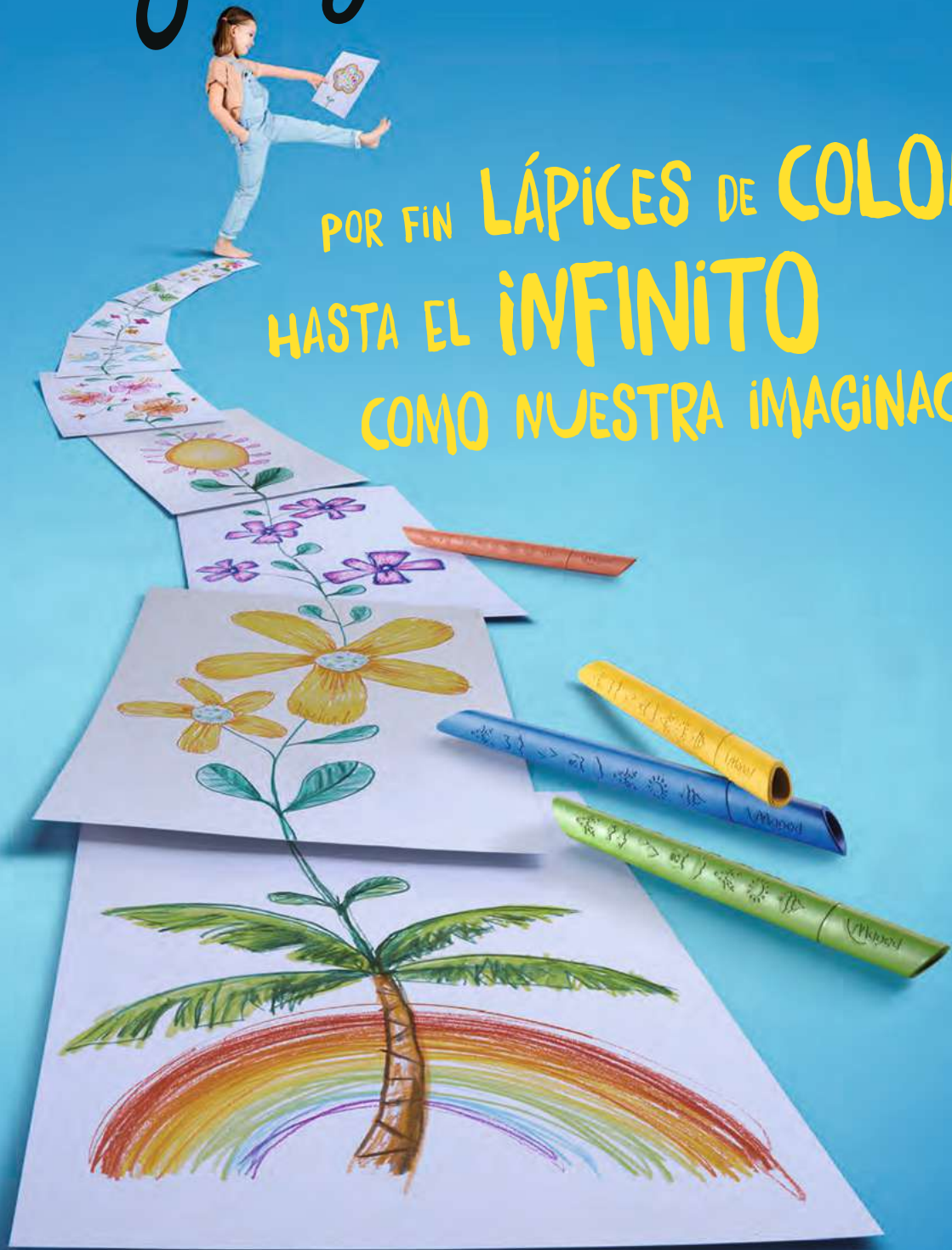

Lápices Infinity

- ▶ Una gama de lápices de colores innovadores que duran como media 10 veces más que nuestros lápices Strong, según nuestras pruebas internas
- ▶ Lápiz 100% mina, 100% utilizable, 0 residuos, cumple con la normativa de los juguetes
- ▶ No hace falta afilarlos, se van afinando solos al colorear
- ▶ Ergonomía: lápiz triangular para mejorar la sujeción
- ▶ Diseño original y patentado que permite al niño colorear por los 2 lados



Packs



COLOR



861600



861601



861602



861604

| ref | •/•• | | |
|--------|--------|--------------------------------|---|
| 861600 | 12-180 | x12 Lápices |  |
| 861601 | 12-72 | x24 Lápices |  |
| 861602 | 12-180 | x12 Lápices - Versión Francesa |  |
| 861604 | 12-72 | x24 Lápices - Versión Francesa |  |



Formato escuela - Infinity

- Packs especialmente diseñada para los proveedores de material escolar
- Paleta de 12 y 24 colores
- Packs para disponer sobre la mesa con un compartimento por color, fácil de colocar y transportar

NEW!



861607



861605



861606

| ref | */** | | |
|--------|--------|--------------|---|
| 861607 | 12-180 | x12 Lápicos |  |
| 861605 | -20 | x72 Lápicos |  |
| 861606 | -12 | x144 Lápicos |  |

Expositor de mostrador - Infinity

- Entrega lleno
- Material: cartón
- Las dimensiones vienen indicadas para un display montado (incluyendo cartelas)
- Características: anchura 378.5 mm, profundidad 180 mm, altura 284 mm
- Zona de prueba
- Incluye 1 cartela extraíble



NEW!



| ref | */** | | |
|--------|-------|------------------------------------|---|
| 993329 | 24-72 | 24 Piezas x24 EAN 315414 861609 |  |

Lápices Strong

- ▶ Una gama de lápices con minas ultra resistentes: Ø 3.2 mm (Ø 4 mm para lápices jumbo). De acuerdo a nuestras pruebas internas, son un 37% más resistentes que nuestros lápices Star
- ▶ Lápices de color de resina, cumple con la normativa de juguetes
- ▶ Ergonomía: lápiz triangular para mejorar la sujeción
- ▶ Fáciles de afilar, no se forman astillas



Packs

- Fabricadas con un 45% de material reciclado y un 25% de material de origen natural (35% y 22% para los jumbo)
- Embalaje de cartón reciclable



COLOR



862712



862718



862724



862812



863312

| ref | e/** | | |
|--------|--------|--|--|
| 862712 | 12-180 | x12 Lápices <i>El 1% del volumen de negocios dedicada a financiar iniciativas en favor del acceso y el apoyo a la educación</i> | |
| 862718 | 12-108 | x18 Lápices | |
| 862724 | 12-72 | x24 Lápices <i>El 1% del volumen de negocios dedicada a financiar iniciativas en favor del acceso y el apoyo a la educación</i> | |
| 862812 | 24-216 | x12 Lápices Mini | |
| 863312 | 12-84 | x12 Lápices Jumbo | |

COLOR'peps STRONG

MINAS SUPERRESISTENTES



INCLUSO PARA
MÁS
LAS IDEAS
LOCAS

Estuches promocionales



- Fabricadas con un 45% de material reciclado y un 25% de material de origen natural
- Embalaje de cartón reciclable
- La caja viene con etiquetas para poner el nombre del niño
- ¡Ideal para no perder el material en la escuela!



862725



862723

| ref | */** | | |
|--------|--------|--|--|
| 862725 | 12-180 | x12 Lápices + 12 etiquetas gratis |  |
| 862723 | 12-144 | x12 Lápices + 1 Black Peps con goma de borrar + 1 sacapuntas Vivo gratis |  |

Caja Metálica

- Fabricadas con un 45% de material reciclado y un 25% de material de origen natural
- Toda la calidad y la resistencia de los lápices Strong, combinadas con la protección y el diseño lúdico de una caja de metal
- Caja resistente y reutilizable
- Enganchable y compacta: dimensiones optimizadas en lineal



862714



862715



862716

| ref | */** | | |
|--------|--------|-------------|---|
| 862714 | 12-120 | x12 Lápices |  |
| 862715 | 12-72 | x18 Lápices |  |
| 862716 | 8-24 | x24 Lápices |  |



Tubo Metálico

- Fabricadas con un 45% de material reciclado y un 25% de material de origen natural
- Toda la calidad y resistencia de los lápices Strong combinadas con la protección de un tubo de metal decorado



862744

862745

862746



Smart Box

- Caja de plástico ultra-resistente a los golpes
- Compacto: gracias a su bisagra de 360° ocupa muy poco espacio en la mesa
- Astuto: sistema lúdico de palanca para una sujeción fácil de los lápices
- Innovación patentada



832032



832035

| ref | */** | | |
|--------|-------|------------------------------|---|
| 862744 | 24-96 | x12 Lápices - Inner decorado |  3 154148 627449 |
| 862745 | 12-48 | x24 Lápices - Inner decorado |  3 154148 627456 |
| 862746 | 12-36 | x36 Lápices - Inner decorado |  3 154148 627463 |

| ref | */** | | |
|--------|-------|--------------------------|---|
| 832032 | 12-48 | x12 Lápices + accesorios |  3 154148 320326 |
| 832035 | 12-48 | x15 Lápices: 12 + 3 Fluó |  3 154148 320357 |

Lápices Star

- ▶ Una gama de lápices de varios colores
- ▶ Lápices de color de madera de calidad
- ▶ Cumple con la normativa de juguetes
- ▶ Mina suave, generoso y resistente: Ø 2.9 mm
- ▶ Ergonomía: lápiz triangular para mejorar la sujeción
- ▶ Fáciles de afilar



Estuches



| ref | */** | | |
|--------|--------|-------------------------------------|--|
| 832002 | 24-288 | x6 Lápices | |
| 183212 | 12-180 | x12 Lápices Inner decorado | |
| 183218 | 12-108 | x18 Lápices Inner decorado | |
| 183224 | 12-72 | x24 Lápices | |
| 832017 | 12-48 | x36 Lápices | |
| 832048 | 12-36 | x48 Lápices | |
| 832072 | 12-36 | x12 Lápices - 72 colores diferentes | |



832002



183212



183218



183224



832017



832048



832072

COLOR

Estuches (FSC certificado)

- Lápices de madera con certificación FSC 100% de bosques gestionados de forma responsable
- Embalaje de cartón reciclable
- Disponible solo en Francia



ETHIC



183212FC



183218FC



183224FC



832017FC



832048FC

| ref | **/** | |
|----------|--------|------------------------------|
| 183212FC | 12-180 | x12 Lápices - Inner decorado |
| 183218FC | 12-108 | x18 Lápices - Inner decorado |
| 183224FC | 12-72 | x24 Lápices |
| 832017FC | 12-48 | x36 Lápices |
| 832048FC | 12-36 | x48 Lápices |



Lápices Pastel (FSC certificado)

- Lápices de madera con certificación FSC 100% de bosques gestionados de forma responsable
- Embalaje de cartón reciclable
- ¡Una paleta de lápices de colores suaves y brillantes!



| ref | e/.. | | |
|----------|--------|--------------------|------------------|
| 832069FC | 12-180 | x12 Lápices Pastel | 3 154 148 320692 |

Lápices World

- ¡La caja de lápices ideal para representar a los niños del mundo!
- Lápices de color de madera de calidad
- Una paleta estándar de 12 lápices + 3 lápices dúo de color carne



| ref | e/.. | | |
|--------|--------|-----------------------------|------------------|
| 832071 | 12-120 | x12 Lápices + 3 Lápices Duo | 3 154 148 320715 |

Lápices Fluo

- Lápices de color de madera de calidad



| ref | e/.. | | |
|--------|--------|-----------------|------------------|
| 832003 | 24-288 | x6 Lápices Fluo | 3 154 148 320036 |

Lápices Mini

- Formato compacto para ganar espacio y facilitar el transporte



| ref | e/.. | | |
|--------|--------|------------------|------------------|
| 832500 | 24-288 | x12 Lápices Mini | 3 154 148 325000 |



Estuches promocionales



183213



832021





832023



832271



832272

| ref | •/•• | | |
|--------|--------|--|---|
| 183213 | 12-144 | x12 Lápices + 1 sacapuntas Vivo gratis |  |
| 832021 | 12-180 | x12 Lápices + 1 lápiz Duo oro/plata gratis |  |
| 832023 | 12-144 | x12 Lápices + 1 Black'Peps con goma de borrar + 1 sacapuntas Vivo gratis |  |
| 832271 | 12-120 | x12 Lápices + 3 Lápices Duo gratis |  |
| 832272 | 12-120 | x12 Lápices + 3 Black'Peps Punta pintada gratis |  |

Caja Metálica

- Toda la calidad y la generosidad de los lápices Star combinadas con la protección y el diseño lúdico de una caja de metal
- Caja resistente y reutilizable
- Enganchable y compacta: dimensiones optimizadas en lineal



832014



832015



832016



832058

| ref | n/° | cont. | img |
|--------|--------|--|-----|
| 832014 | 12-120 | x12 Lápices | |
| 832015 | 12-72 | x18 Lápices Hasta finales de stocks | |
| 832016 | 8-24 | x24 Lápices | |
| 832058 | 6-24 | x48 Lápices | |

COLOR

Lápices decorados

- ▶ Una gama de lápices decorados que encantará a los niños
- ▶ Cumple con la normativa de juguetes
- ▶ Mina blanda y ultra resistente: Ø 2.9 mm
- ▶ Ergonomía: lápiz triangular para mejorar la sujeción
- ▶ Fáciles de afilar



Lápices Monster

- Fabricadas con 38.7% de material reciclado post-industrial
- Embalaje de cartón reciclable
- Lápices de color de resina
- Cuerpo negro



862612

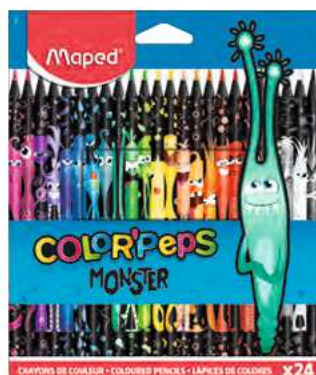

862624



| ref | n/° | cont. | img |
|--------|--------|-----------------------|-----|
| 862612 | 12-180 | x12 Lápices monstruos | |
| 862624 | 12-72 | x24 Lápices monstruos | |



Lápices Animals

- Lápices de color de madera de calidad



832212



832218



832224

| ref | * / ** | | |
|--------|--------|----------------------|---|
| 832212 | 12-180 | x12 Lápices animales |  |
| 832218 | 12-108 | x18 Lápices animales |  |
| 832224 | 12-72 | x24 Lápices animales |  |

Lápices Animals (FSC certificado)



- Lápices de madera con certificación FSC 100% de bosques gestionados de forma responsable
- Embalaje de cartón reciclable
- Disponible solo en Francia



832212FC



832218FC



832224FC

| ref | */** | | |
|----------|--------|----------------------|--|
| 832212FC | 12-180 | x12 Lápices animales | |
| 832218FC | 12-108 | x18 Lápices animales | |
| 832224FC | 12-72 | x24 Lápices animales | |



Expositor de mostrador ColorPeps Best Sellers

- Entrega lleno
- Material: cartón
- Las dimensiones vienen indicadas para un display montado (incluyendo cartelas)
- Características: anchura 462 mm, profundidad 273 mm, altura 400 mm
- Incluye 1 cartela extraíble
- Hasta finales de stocks



| ref | */** | | |
|--------|------|---|--|
| 993325 | 1-18 | 34 Piezas x6 EAN 315414 832212 2 x6 EAN 315414 845422 9 x6 EAN 315414 845420 5 x8 EAN 315414 862624 4 x8 EAN 315414 183224 6 | |

Expositor de mostrador ColorPeps Strong / Ocean

- Entrega lleno
- Material: cartón
- Las dimensiones vienen indicadas para un display montado (incluyendo cartelas)
- Características: anchura 462 mm, profundidad 273 mm, altura 400 mm
- Incluye 1 cartela extraíble
- Hasta finales de stocks



| ref | */** | | |
|--------|------|---|--|
| 993326 | 1-18 | 38 Piezas x6 EAN 315414 984701 3 x8 EAN 315414 845720 6 x8 EAN 315414 845722 0 x8 EAN 315414 862712 8 x8 EAN 315414 862724 1 | |

Gama Escuela

- Una gama especialmente diseñada para los proveedores de material escolar
- Cantidades y formatos adaptados a las escuelas y a las clases (grandes formatos, recipientes para poner en la mesa...)
- ¡Productos que cumplen con la normativa de juguetes, seguros y resistentes!

Rotuladores

- Rotuladores con tinta ultralavable, larga duración
- Punta media bloqueada, conica : Ø 3.6 mm
- Paleta de 12 colores
- Orden vertical para mayor ganancia de espacio
- Base de cartón: estable, resistente, sin ruido



845230LM



845000LM



845004LM

| ref | */** | | |
|----------|-------|------------------|--|
| 845230LM | 12-96 | x12 Rotuladores | |
| 845000LM | -10 | x72 Rotuladores | |
| 845004LM | -4 | x144 Rotuladores | |

Lápices de colores

- Fabricadas con un 45% de material reciclado y un 25% de material de origen natural (35% y 22% para los jumbo)
- Embalaje de cartón reciclable
- Lápices de color de resina ultra resistentes
- Lápiz triangular para mejorar la sujeción
- Mina ultra resistente: Ø 3.2mm, fáciles de afilar
- Paleta de 12 y 24 colores
- Pack x72 : botes de 72 lápices para disponer sobre la mesa
- Pack x144 : 4 botes de 36 lápices para disponer sobre la mesa. poco voluminoso – fácil de colocar y transportar



832030

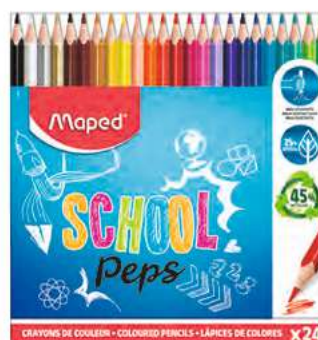

832034



834030

| ref | */** | | |
|--------|--------|--|--|
| 832030 | 12-180 | x12 Lápices | |
| 832034 | 12-72 | x24 Lápices Hasta finales de stocks | |
| 834030 | 12-108 | x12 Lápices Jumbo | |
| 832000 | -20 | x72 Lápices | |
| 832004 | -12 | x144 Lápices | |



832000



832004

ETHIC

Mini-Artistas

- ▶ Color por todas partes en todo momento gracias a los accesorios creativos Color'Peps
- ▶ Perfecto para niños apasionados por el color y que quieren dibujar, colorear, decorar y enriquecer sus dibujos
- ▶ Estimula la imaginación de los niños
- ▶ Cumple con la normativa de juguetes



Rotuladores XXL Brush Tip

- El primer rotulador que permite realizar grandes trazos planos en tiempo récord
- Punta extraancha, ideal para colorear grandes superficies (cielo, mar, hierba, ...)
- Tinta lavable sobre la mayoría de los tejidos
- Punta del pincel extrasuave, bloqueada: Ø 7 mm



| ref | */** | | |
|--------|------|----------------|---|
| 844705 | 6-36 | x5 Rotuladores |  |

Rotuladores Duo Stamp

- Función sello: ¡una nueva manera de completar los dibujos!
- Punta doble: una punta ancha para colorear, una punta sello para decorar
- 8 sellos con motivos diferentes
- Tinta ultralavable sobre la mayoría de los tejidos y en la piel con agua y jabón
- Punta ancha bloqueada, cónica: Ø 7.5 mm



| ref | */** | | |
|--------|------|----------------|---|
| 846808 | 6-18 | x8 Rotuladores |  |

Rotuladores Magic

- Función mágica: la tinta cambia de color al pasar del rotulador por encima
- Revelación instantánea del color
- Perfecto para decorar un fondo ya coloreado
- Punta media bloqueada, cónica: Ø 3.6 mm



| ref | */** | | |
|--------|-------|---|---|
| 844612 | 12-96 | x10 Rotuladores (incluye 2 reveladores) |  |



Rotuladores Glitter

- Rotuladores con tinta de purpurina
- Perfecto para decorar tus creaciones
- Alta densidad de purpurinas
- Punta media, ojival: \varnothing 2.8 mm



Rotuladores Mini Power

- ¡Pequeños pero resistentes!
- Tinta ultralavable sobre la mayoría de los tejidos y en la piel con agua y jabón
- Función sello en los tapones
- Punta ancha bloqueada, cónica: \varnothing 6.5 mm



ref / **

847110

12-144

x10 Rotuladores (caja de cartón con efecto de purpurina)



3 154148 471103

ref / **

846612

12-72

x12 Rotuladores



3 154148 466123

Rotuladores Brush

- Perfecto para croquis, dibujos, mangas, ilustraciones o caligrafía.
- Tinta ultralavable sobre la mayoría de los tejidos y en la piel con agua y jabón
- Punta blanda extraflexible: Ø 2.8 mm



| ref | */** | | |
|--------|-------|-----------------|---|
| 848010 | 12-96 | x10 Rotuladores |  |

Rotuladores Duo Tip

- 2 en 1: Punta fina 2 mm para dibujar y Punta ancha 3,9 mm para rellenar superficies amplias superficies
- Tinta ultralavable sobre la mayoría de los tejidos y en la piel con agua y jabón



| ref | */** | | |
|--------|--------|-----------------|---|
| 849010 | 12-144 | x10 Rotuladores |  |

Rotuladores Duo Colors

- Astuto y práctico: ¡el doble de colores!
- Tinta ultralavable sobre la mayoría de los tejidos y en la piel con agua y jabón
- Punta media bloqueada, cónica: Ø 4.75 mm



| ref | */** | | |
|--------|--------|------------------------------|---|
| 847010 | 12-144 | x10 Rotuladores = 20 colores |  |

Rotuladores Window

- Las ventanas como nueva superficie para colorear!
- Utilizables en cualquier superficie de vidrio
- Gran diámetro para un mejor agarre
- Fácil de limpiar: se borra totalmente gracias al paño microfibra empapado de agua
- Características del paño: 20x20 cm
- Punta ancha bloqueada, ojival: Ø 5 mm



| ref | */** | |
|--------|------|---|
| 844820 | 8-32 | x6 Rotuladores + 1 paño microfibra gratis |



Lápices de colores Oops

- Lápices borrables que combinan una capacidad de dibujar el papel muy buena con una capacidad increíble de ser borrados
- Lápices de color de resina, incluye goma
- Ergonomía: lápiz triangular para mejorar la sujeción
- Diámetro de mina estándar: Ø 2.9 mm



832812

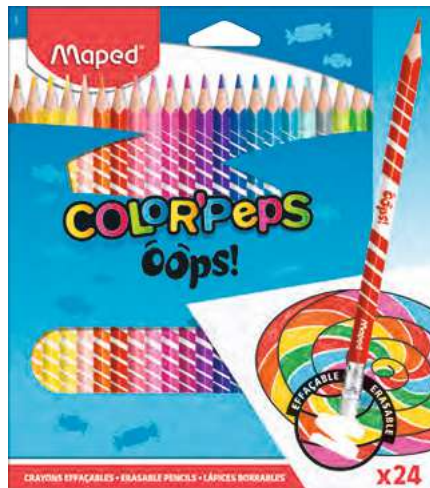

832824



| ref | */** | |
|--------|--------|----------------------------------|
| 832812 | 12-144 | x12 Lápices - Con goma de borrar |
| 832824 | 12-72 | x24 Lápices - Con goma de borrar |



Lápices de colores Duo

- Genial formato 2 en 1: ¡el doble de color! ¡Ocupan la mitad de espacio en el estuche!
- Único: 1 lápiz oro/plata
- Mina blanda y resistente
- Ergonomía: lápiz triangular para mejorar la sujeción
- Diámetro de mina estándar: Ø 2.9 mm



829600



829601



829602



COLOR

| ref | */** | | |
|--------|--------|---|---|
| 829600 | 12-180 | x12 Lápices Bicolor = 24 colores Inner Decorado |  |
| 829601 | 12-108 | x18 Lápices Bicolor = 36 colores Inner Decorado |  |
| 829602 | 12-72 | x24 Lápices Bicolor = 48 colores |  |

Lápices de colores Duo (FSC certificado)

- Lápices de madera con certificación FSC 100% de bosques gestionados de forma responsable
- Embalaje de cartón reciclable
- Genial formato 2 en 1: ¡el doble de color! ¡Ocupan la mitad de espacio en el estuche!
- Único: 1 lápiz oro/plata
- Mina blanda y resistente
- Ergonomía: lápiz triangular para mejorar la sujeción
- Diámetro de mina estándar: Ø 2.9 mm
- Disponible solo en Francia



829600FC



829601FC



829602FC



ETHIC

| ref | */** | | |
|----------|--------|---|---|
| 829600FC | 12-180 | x12 Lápices Bicolor = 24 colores Inner Decorado |  |
| 829601FC | 12-108 | x18 Lápices Bicolor = 36 colores Inner Decorado |  |
| 829602FC | 12-72 | x24 Lápices Bicolor = 48 colores |  |





Lápices de colores Aqua

- Mina acuareable blanda y resistente
- Aplicar - Humidificar - Colorear
- Ergonomía: lápiz triangular para mejorar la sujeción
- Diámetro de mina estándar: Ø 2.9 mm



836011



836012



836013



| ref | */** | |
|--------|--------|--|
| 836011 | 12-180 | x12 Lápices + 1 pincel gratis |
| 836012 | 12-108 | x18 Lápices + 1 pincel gratis Hasta finales de stocks |
| 836013 | 12-72 | x24 Lápices + 1 pincel gratis |



3 154 148 360117



3 154 148 360124



3 154 148 360131

Pegamento con purpurina

- Facilidad de uso : precisión y fluidez
- Alta densidad de purpurinas
- Tubos plástico de 10.5 ml



Tizas para aceras

- ¡Para dejar volar tu imaginación y crear dibujos y juegos gigantescos!
- Ideal en el asfalto
- Gran diámetro para un mejor agarre
- Fácil de limpiar: se elimina completamente con agua



COLOR

| ref | */** | |
|--------|------|----------|
| 813010 | 6-36 | x9 Tubos |



3 154 148 130109

| ref | */** | |
|--------|------|----------|
| 936010 | 6-60 | x6 Tizas |



3 154 149 1360109

Lápices Twist

- Lápices de cera con sistema "Twist": girar para sacar la mina
- Limpios: no ensucian las manos
- Larga duración : no hace falta sacarles punta



| ref | */** | |
|--------|-------|-------------------|
| 860612 | 12-48 | x12 Lapices Twist |



3 154 148 606123

Ceras de colores - Wax

- Lápices de cera suaves con colores vivos
- Cuerpo bajo funda protectora de papel que no mancha las manos
- Ergonomía: lápiz triangular para mejorar la sujeción





861011



861012



861013

| ref | */** | | |
|--------|--------|-----------------|---|
| 861011 | 12-144 | x12 Lápices Wax |  3 154148 610113 |
| 861012 | 12-96 | x18 Lápices Wax |  3 154148 610120 |
| 861013 | 12-72 | x24 Lápices Wax |  3 154148 610137 |

Ceras de colores - PlasticoClean

- Lápices de plástico con 1 lado precisión y 1 lado liso
- Limpios: no ensucian las manos
- Larga duración: 3 veces más tiempo que un lápiz estándar
- Fáciles de afilar
- Ergonomía: lápiz triangular para mejorar la sujeción



862011



862013

| ref | */** | | |
|--------|--------|-------------------------|---|
| 862011 | 12-144 | x12 Lápices de plástico |  3 154148 620112 |
| 862013 | 12-48 | x24 Lápices de plástico |  3 154148 620136 |

Ceras de colores - Óleo pasteles

- Pasteles al aceite extrasuaves
- Colores brillantes y cobertura de una superficie muy amplia
- Formato máxi y triangular para mejorar la sujeción
- Multiplicidad de efectos: rascado, secado, superposición...

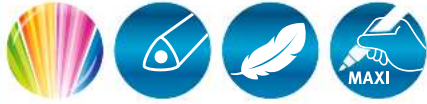

864010



864011



864012

| ref | n/° | descripción | barcode |
|--------|--------|---|-----------------|
| 864010 | 12-108 | x12 Lápices pasteles | 3 154148 640103 |
| 864011 | 12-96 | x18 Lápices pasteles Hasta finales de stocks | 3 154148 640110 |
| 864012 | 12-72 | x24 Lápices pasteles | 3 154148 640127 |

Ceras de colores - Gel

- Lápices de gel acuarelables, muy blandos y que ofrecen una sensación de deslizamiento incomparable
- Cuerpo plástico con sistema "twist", que mantiene las manos limpias
- Colores muy vivos y de gran poder cubriente



836306



836310

| ref | n/° | descripción | barcode |
|--------|--------|--------------------|-----------------|
| 836306 | 12-144 | x6 Lápices de gel | 3 154148 363064 |
| 836310 | 12-48 | x10 Lápices de gel | 3 154148 363101 |

Kit de coloreado de 100 piezas

- ¡Un estuche con 100 herramientas de coloreado de gran calidad!
- La caja, práctica y portátil, permite guardarlas y transportarlas a todas partes
- El producto ideal para regalar a los artistas
- **Contenido:** 36 Rotuladores lavables con punta media + 36 Lápices de color de resina + 24 Ceras Wax + 1 Rotulador Brush con punta pincel + 1 Lápices de grafito + 1 Goma + 1 Sacapunta

100
PCS



ref

*/**

907003

-6

x100 Herramientas



3 154149 070039

Kit de coloreado brillante

- ¡Un estuche moderno y con abundante purpurina!
- Una caja decorada y brillante para guardar y reutilizar
- ¡Una gran variedad de accesorios para colorear y poner purpurina en tus dibujos!
- **Contenido:** 10 Lápices de color de resina + 8 Rotuladores de purpurina + 8 Ceras Wax + 5 Tubos de cola de purpurina



ref

*/**

984722

-4

Kit brillante en caja de cartón con efecto de purpurina



3 154149 847228



Tempera

- ▶ La pintura infantil es una actividad ideal para descubrir los colores, estimular la imaginación, despertar la creatividad y entrenar la motricidad fina.
- ▶ Cumple la regulación vigente de juguetes para una utilización totalmente segura
- ▶ MAPED propone una gama de pinturas al agua de calidad superior, provista de súper poderes, ¡que no pasará inadvertida!
- ▶ ¡Pinturas al agua con colores de alta pigmentación, vivos y mezclables entre sí para crear infinitos tonos!



Ultra-lavable listas para usar - Botellas surtidas

- Una formulación única en el mercado que combina una ultra-lavabilidad sobre el algodón y una excelente opacidad
- Lavable en máquina a partir de 30°
- Textura untuosa lista para usar (también se puede diluir ligeramente)
- Un formato inédito: botellitas muy prácticas de 75ml
- Diseño exclusivo: colección aleatoria de 6 mini súper héroes



810010



810011



810012

| ref | e/** | | |
|--------|------|---|-------------------|
| 810010 | 5-20 | | |
| | | x6 Botellas de pintura al agua Colores primarios | 3 154 148 100 102 |
| 810011 | 5-20 | | |
| | | x6 Botellas de pintura al agua Colores secundarios | 3 154 148 100 119 |
| 810012 | 5-20 | | |
| | | x5 Botellas de pintura al agua 3 fluos + 2 metal (oro y plata) | 3 154 148 100 126 |



COLOR

Tubos

- Una formulación concentrada, ideal para obtener una paleta con efectos de transparente a opaco al diluir con + o - agua
- Práctico y fácil de abrir: tapón de rosca
- Tubos de aluminio de 12 ml
- Caja de plástico irrompible con 4 compartimentos para diluir la pintura



810510



810520



810540

| ref | e/** | | |
|--------|-------|---|-------------------|
| 810510 | 10-60 | x12 Tubos de pintura al agua - Caja de cartón | |
| | | | 3 154 148 105 107 |
| 810520 | 10-40 | x12 Tubos de pintura al agua - Caja de plástico | |
| | | | 3 154 148 105 206 |
| 810540 | 10-60 | x5 Tubos de pintura al agua - Blister | |
| | | | 3 154 148 105 404 |

Pastillas

- Tamaño perfecto para un fácil almacenamiento larga vida útil
- Diluir con más o menos agua para obtener un efecto acuarela u opaco
- Lavado fácil: caja de plástico irrompible con tapa desmontable
- Diámetro 30 mm
- Pincel sintético incluido



| ref | */** | | |
|--------|-------|---|---|
| 811520 | 10-60 | x12 Pastillas de pintura al agua + 1 pincel |  3 154148 115205 |

Accesorios de pintura

► Accesorios funcionales y super divertido!

Bote para agua

- Función anti vuelco = súper estable
- Función reposa pincel o sistema de escurrido
- Fácil de limpiar - 2 compartimentos
- Posibilidad de colocar 12 rubos en el interior del cubo de agua



Pinceles

- ¡Un juego de 4 pinceles para usar en todas tus actividades creativas!
- Cerdas sintéticas perfectas para extender gouaches, pintura acrílica, pegamento, tinta...
- 4 tamaños para trazos más o menos finos : 3 redondos (nº4, 10, 14), 1 plano (nº14)
- Mangos de madera de colores, adaptados a las manos de los niños



| ref | */** | | |
|--------|------|-------------------|---|
| 811310 | 6-24 | x1 Bote para agua |  3 154148 113102 |

| ref | */** | | |
|--------|--------|-------------|---|
| 867810 | 12-144 | x4 Pinceles |  3 154148 678106 |

Paleta de pintura

- Diseño divertido y original
- Soportes reposa pinceles
- Fácil de limpiar
- 6 compartimentos anchos



| ref | e/.. | | |
|--------|-------|-----------|---|
| 811410 | 20-80 | x1 Paleta |  |

Bata de protección

- Un indispensable para las primeras todas las actividades creativas !
- Fácil de poner y de cerrar gracias al velcro en la espalda
- Mangas largas elásticas
- Material flexible e impermeable, fácilmente lavable : delante y detrás en PEVA, mangas en poliéster
- Para los niños de 4 a 8 años : de 102 a 128 cm



| ref | e/.. | | |
|--------|-------|---------|---|
| 820410 | 10-60 | x1 Bata |  |

COLOR

Actividades para colorear

- ▶ **Maped se lanza a por un mercado completamente nuevo:** el de las actividades de gran calidad para colorear
- ▶ **Su posicionamiento es absolutamente único:** una gama amplia e innovadora. Innovadora por sus diseños (fotos en blanco y negro e ilustraciones) y por la variedad de la oferta: diferentes formatos y materiales (papel, cartón, plástico, lienzo, actividades con efectos) que permiten utilizar todas las herramientas para colorear
- ▶ **Maped destaca por la riqueza de sus ilustraciones:** 7 ilustradores han trabajado sobre 10 temas adorados por los niños



Papeles de colorear con decoraciones metalizadas

- Un diseño con reflejos metalizados que dará un efecto brillante a los dibujos para colorear
- Decoraciones metalizadas doradas, plateadas o cobrizas
- 10 páginas / 10 ilustraciones diferentes
- Formato A4 : 210 x 297 mm
- Gramaje: 200g/m²

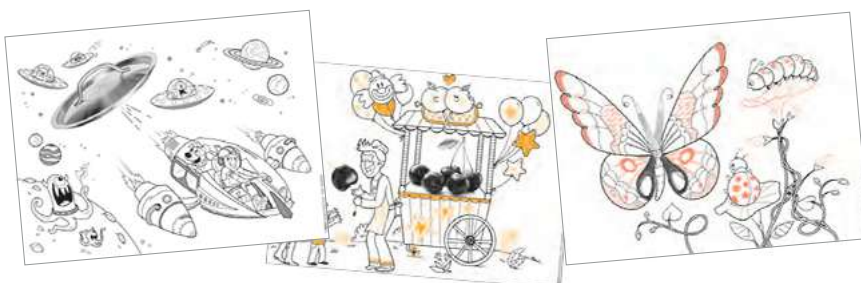

| ref | e/.. | | |
|--------|-------|--|---|
| 831224 | 12-24 | x10 Hojas de papeles con decoraciones metalizadas Colores surtidos - Inner decorado |  |

Papeles para pintar con pastillas de pintura incluidas

- **Muy práctica y limpia:** la paleta de pintura ya está en el papel, solo hay que humidificar el pincel y empezar a pintar
- **Parte con las pastillas extraíble para conservar un bonito coloreado**
- 10 páginas / 10 ilustraciones diferentes
- Pincel gratis
- Formato: 200 x 240 mm
- Gramaje: 300g/m²



| ref | */** | | |
|--------|-------|--|--|
| 831225 | 12-24 | | x10 Hojas de papel para pintar + 1 pincel Colores surtidos - Inner decorado |



3 154148 312253



Soportes para colorear después de montar

- **Soporte 3D:** el dibujo cobra vida con elementos en relieve
- 3 soportes 3D / 3 ilustraciones diferentes
- Pastillas adhesivas incluidas para dar relieve
- Formato A4: 210 x 297 mm
- Gramaje: 350g/m²

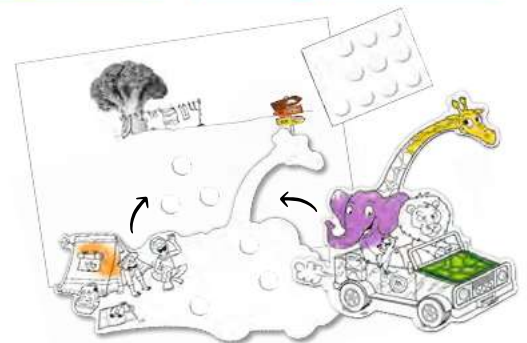

| ref | */** | | |
|--------|-------|--|---|
| 831226 | 12-24 | | x3 Soportes 3D + pastillas adhesivas Colores surtidos - Inner decorado |



3 154148 312260

Bolsa de tela para colorear

- Bolsa de tela para colorear con rotuladores textiles: ya sea con rotuladores lavables para volver a empezar hasta el infinito después de lavar en máquina o rotuladores permanentes
- Una bolsa personalizada y única
- Tamaño de la bolsa: 300 x 230 mm (un documento A4 cabe en la bolsa)
- Composición: 100% poliéster



| | | | |
|--------|-------|-------------------------------------|------------------|
| ref | 6 | 6 | |
| 831227 | 12-24 | x1 Bolsa de tela - Colores surtidos | 3 154 148 312277 |
| | | Inner decorado | |

COLOR

Manteles individuales para colorear

- ¡Una actividad perfecta para una fiesta de cumpleaños!
- 15 juegos / 15 ilustraciones diferentes
- Formato A3 : 297 x 420 mm
- Gramaje : 120g/m²

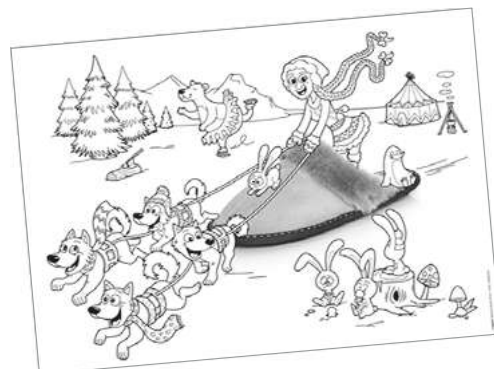

| | | | | |
|--------|-------|-----------------------------------|------------------|---|
| ref | 3 | 3 | 3 | 3 |
| 831210 | 12-24 | x15 Manteles individuales | 3 154 148 312109 | |
| | | Colores surtidos - Inner decorado | | |

Postales para colorear

- Una manera bonita de escribir a tus seres queridos
- Espacio en la parte posterior de la postal para escribir un mensaje y la dirección
- 10 postales / 10 ilustraciones diferentes
- Formato: 100 x 150 mm
- Gramaje: 300g/m²

4+



| ref | */** | | |
|--|------|---|---|
| 831211 | 6-48 |  3 3 |  |
| x10 Postales para colorear Colores surtidos | | | |

Libro de dibujos para colorear

- Hojas extraíbles para mostrar o regalar tus maravillosos dibujos para colorear
- 15 páginas / 15 ilustraciones diferentes
- Formato: 200 x 200 mm
- Gramaje: 300g/m²

4+



| ref | */** | | |
|---|------|--|---|
| 831212 | 6-12 |  3 3 |  |
| x1 Libro de dibujos Colores surtidos | | | |

Papeles mágicos con efectos para colorear

- ¡Es mágico! Cuando entra en contacto con la tinta, aparecen unos dibujos
- Se utiliza con rotuladores para colorear
- 15 páginas / 15 ilustraciones diferentes
- Formato A4: 210 x 297 mm
- Gramaje: 120g/m²



4+

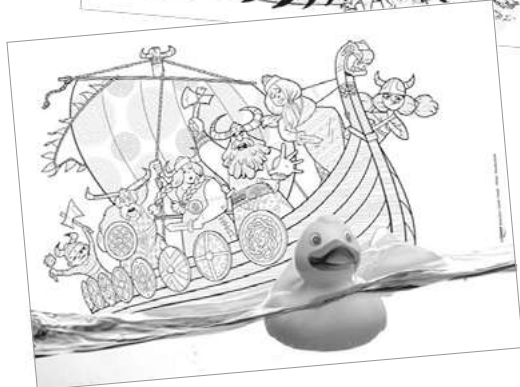

831214



831228

| ref | */** | | |
|---|------|---|---|
| 831214 | 6-24 |  3 3 |  |
| x15 Papeles mágicos con efectos para colorear Colores surtidos | | | |
| 831228 | 6-24 |  |  |



Mini juegos para colorear

- Juegos de bolsillo para colorear y llevar a cualquier parte: unir los puntos, buscar las 7 diferencias, busca y encuentra...
- 20 páginas / 20 mini juegos diferentes
- Formato : 150 x 210 mm
- Gramaje : 300g/m²

5+

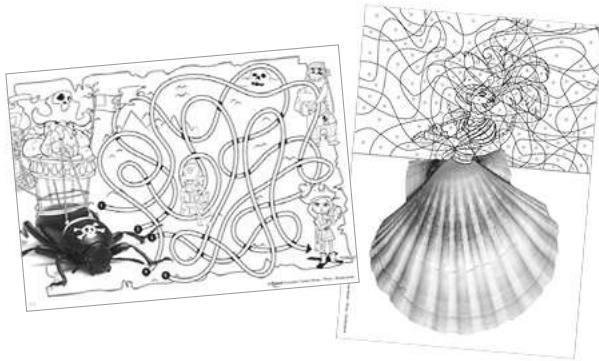

| | | | | |
|--------|------|--|-------------------------------|-----------------|
| ref | 6-36 | | x20 Mini juegos para colorear | |
| 831216 | | | | 3 154148 312161 |

COLOR

Pintura mágica

- ¡Mágico! La pintura aparece en el dibujo al contacto con el agua
- Limpio: no se necesita pintura
- 10 páginas / 10 ilustraciones diferentes
- Pincel gratis
- Formato A4 : 210 x 297 mm
- Gramaje : 300g/m²



| | | | | | | |
|--------|------|--|--|--|-------------------------------|-----------------|
| ref | 6-24 | | | | x10 Pintura mágica + 1 Pincel | |
| 831217 | | | | | Colores surtidos | 3 154148 312178 |

Lámina individual de plástico para colorear

- Colorear - Lavar - Volver a empezar
- Lámina (de plástico) que se lava con agua. El niño podrá colorear las veces que quiera
- Se puede utilizar con lápices de colores, rotuladores, ...
- 2 imágenes / 2 diferentes ilustraciones
- Formato A3 : 297 x 420 mm

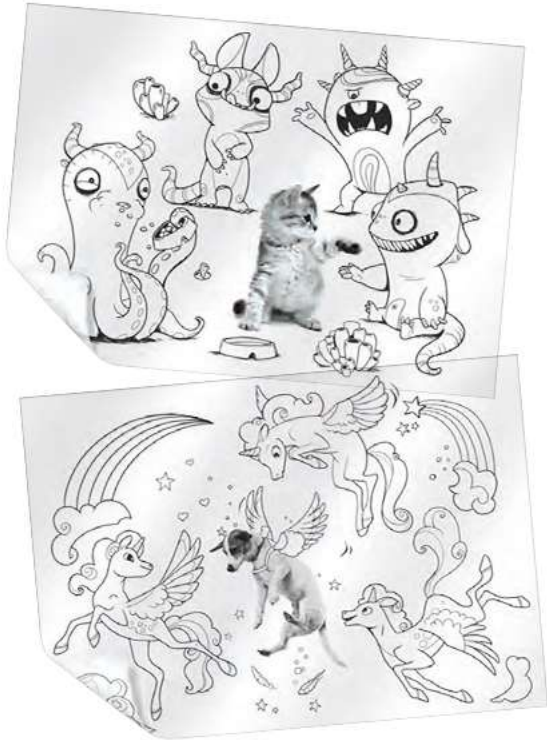

831218 / 821222



831218 / 831223

| ref | */** | | |
|--------|-------|--|-----------------|
| 831218 | 12-24 | 3 3 | 3 154148 312185 |
| | | x1 Lámina de plástico para colorear Colores surtidos - Inner decorado | |
| 831222 | 6-24 | | 3 154148 312222 |
| 831223 | 6-24 | | 3 154148 312239 |



Expositor de mostrador – Actividades para colorear

- Entrega lleno
- Material: cartón
- Las dimensiones vienen indicadas para un display montado (incluyendo cartelas)
- Características: anchura 586 mm, profundidad 290 mm, altura 456 mm
- Promoción cliente incluida: 30 Mini Color'Peps Star x6
- Incluye 1 cartela extraíble
- Hasta finales de stocks



| ref | */** | | |
|--------|------|---|-----------------|
| 993328 | 1-9 | 30 Piezas x6 EAN 315414 831210 9 x6 EAN 315414 831211 6 x6 EAN 315414 831212 3 x6 EAN 315414 831214 7 x6 EAN 315414 831216 1 | 3 154149 933280 |



ESCOLAR

I N T E L I G E N T E × D U R A B L E × O R I G I N A L

ESCOLAR

UN CONCEPTO ÚNICO DE ESTUCHES:



4 COLECCIONES DE TENDENCIA

elegidos por los niños,
pero también por los padres



UNA PERSONALIZACIÓN SIN FIN

con un lado del estuche
para colorear en mil colores



UNA APERTURA XXL

para encontrar fácilmente
sus accesorios favoritos

DOS LOOKS EXTERNOS

porque el estuche es reversible



~~¡PROHIBIDO~~
DIBUJAR

EN LOS
ESTUCHES!



GRAN CIERRE DE CREMALLERA

para una apertura máxima

EASY ZIP MAPED

para facilitar la apertura del estuche

TEJIDO LAVABLE Y RESISTENTE

2 grosores de poliéster de 300D

COLECCIÓN «BASIC»

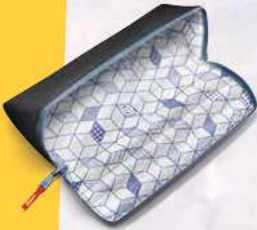

Negro

931900

12-48



3 154 149 319008



Violeta

931901

12-48



3 154 149 319015

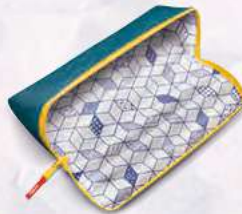

Verde

931902

12-48



3 154 149 319022

COLECCIÓN «TRENDY»

Verde

931903

12-48



3 154 149 319039



Rosa

931904

12-48



3 154 149 319046



COLECCIÓN «EFFECT»

Azul

931905

12-48



3 154 149 319053



Rosa

931906

12-48



3 154 149 319060



COLECCIÓN «PATTERN»

Azul

931907

12-48



3 154 149 319077



Rosa

931908

12-48



3 154 149 319084



EXPOSITOR DE MOSTRADOR

24 Piezas

x6 EAN 3154149319008

x4 EAN 3154149319022

x4 EAN 3154149319015

x2 EAN 3154149319039

x2 EAN 3154149319046

x1 EAN 3154149319053

x1 EAN 3154149319060

x2 EAN 3154149319077

x2 EAN 3154149319084

1-24 993423



3 154 149 9934232



Estuches de neopreno

► Unos estuches decorados de neopreno que resisten el paso del tiempo y todas las aventuras de los estudiantes

Estuches formato tubo

- ¡Colores duraderos y brillantes!
- Todas las referencias están disponibles en 3 colores distintos con el mismo diseño
- Dimensiones: 210 mm de largo y 95 mm de diámetro
- Edición limitada



934836



934839



934850



934851

| ref | */** | | |
|--------|------|------------|-----------------|
| 934836 | -12 | 4 4 4 | 3 154149 348367 |
| | | Mosaic | |
| 934839 | -12 | 4 4 4 | 3 154149 348398 |
| | | Emoticons | |
| 934850 | -12 | 4 4 4 | 3 154149 348503 |
| | | Street art | |
| 934851 | -12 | 4 4 4 | 3 154149 348510 |
| | | Skull | |

Estuches formato sobre

- ¡Colores duraderos y brillantes!
- Todas las referencias están disponibles en 3 colores distintos con el mismo diseño
- Dimensiones: 205 mm de largo y 130 mm de diámetro
- Edición limitada



934726



934755

| ref | */** | | |
|--------|------|---------|-----------------|
| 934726 | -12 | 4 4 4 | 3 154149 347261 |
| | | Mandala | |
| 934755 | -12 | 4 4 4 | 3 154149 347551 |
| | | Ethnic | |

Estuches multiproductos específicos

► Estuches decorados y llenos de una amplia variedad de accesorios escolares

1 Piso

- Contenido 31 artículos :
 8 lápices de color
 + 14 rotuladores
 + 1 sacapuntas
 + 1 kit de trazado (reglas de 15 cm, escuadra 45° y 60°)
 + 1 goma
 + 2 lápices graphite HB
 + 2 bolígrafos
- Hasta finales de stocks



967811



967812



967813



967814



967816

| ref | e/.. | | |
|--------|------|----------|-----------------|
| 967811 | 8-32 | Karate | 3 154149 678112 |
| 967812 | 8-32 | Fairy | 3 154149 678129 |
| 967813 | 8-32 | Princess | 3 154149 678136 |
| 967814 | 8-32 | Jungle | 3 154149 678143 |
| 967816 | 8-32 | Totem | 3 154149 678167 |

2 Pisos

- Contenido 34 artículos :
 12 lápices de color
 + 12 rotuladores
 + 1 sacapuntas
 + 1 tijeras 13 cm
 + 1 kit de trazado (reglas de 15 cm, cartabón 60°, transportador)
 + 1 compás
 + 1 goma
 + 2 lápices graphite HB
 + 1 rotuladores de punta fina
- Hasta finales de stocks



967430



967431



967434



967413

| ref | e/.. | | |
|--------|------|---------|-----------------|
| 967430 | 4- | Cars | 3 154149 674305 |
| 967431 | 4- | Girly | 3 154149 674312 |
| 967434 | 4- | Pirates | 3 154149 674343 |
| 967413 | 4- | Totem | 3 154149 674138 |

Estuches multiproductos transparente

► Estuches sobrios y llenos de una amplia variedad de accesorios escolares

Escritura Set - 8 Piezas

- 1 Fluo Peps amarillo
- + 1 goma Mini
- + 3 lápices Graphite Black'Peps (HB)
- + 1 sacapuntas
- + 2 bolígrafos, azul y negro



| ref | */** | |
|--------|-------|--|
| 899707 | 10-60 |  3 154148 997078 |

Exam Pack - 10 Piezas

- 1 estuche transparente con 1 compás mina de metal
- + 1 regla plastica 15 cm
- + 1 escuadra Geometric 45°/16 cm
- + 1 Fluo Peps amarillo
- + 1 goma Essentials Soft Larga
- + 1 lápice Graphite Black'Peps (HB)
- + 1 sacapuntas
- + 3 bolígrafos, azul, negro y verde



| ref | */** | |
|--------|-------|---|
| 899704 | 12-72 |  3 154148 997047 |

School Pack - 10 Piezas

- 1 estuche transparente con 1 regla plastica 15 cm
- + 1 Fluo Peps amarillo
- + 1 goma Essentials Soft Larga
- + 2 lápices Graphite Black'Peps (HB)
- + 1 tijeras 13 cm
- + 1 sacapuntas
- + 3 bolígrafos, azul, negro y verde



| ref | */** | |
|--------|-------|---|
| 899705 | 12-72 |  3 154148 997054 |

Sin compartimento de recogida

► Una gama de sacapuntas sin compartimento de recogida: para todos los amantes de la sencillez básica o moderna, de metal o plástico.

Vivo - 1 Orificio



006303



506300

| ref | e/.. | | | | |
|--------|---------|----|----|----|------------------|
| 006303 | 30-360 | | | | |
| | | x3 | | | 3 154 140 063030 |
| 506300 | 75-3600 | | | | |
| | | 25 | 25 | 25 | 3 154 145 063004 |

Vivo - 2 Orificios



| ref | e/.. | | | | |
|--------|---------|----|----|----|------------------|
| 062511 | 30-1440 | | | | |
| | | 10 | 10 | 10 | 3 154 140 625115 |

Vivo Pastel - 1 Orificio



| ref | e/.. | | | | |
|--------|---------|----|----|----|------------------|
| 063011 | 75-3600 | | | | |
| | | 25 | 25 | 25 | 3 154 140 630119 |

Vivo Maxi

- Para lápices extra grandes, hasta 16 mm de diámetro



| ref | */** | | | |
|--------|---------|--|----|---|
| 062911 | 36-1728 |  | 12 |  |



3 154140 629113

Vivo Fancy – 1 Orificio

- Diversión: 5 monstruos diferentes



| ref | */** | | | |
|--------|---------|--|----|---|
| 063511 | 65-3120 |  | 22 |  |



3 154140 635114





Boogy - 1 Orificio



063210



063211

| ref | */** | | | |
|--------|---------|--|---|---|
| 063210 | 30-360 |  |  |  |
| | | x3 | | |
| 063211 | 75-3600 |  | 30 |  |



3 154140 632106



3 154140 632113

Elements - 1 Orificio

- Tacto blando para facilitar la empuñadura
- Sistema de enganche para colgar en el estuche



001601

501600

| ref | e/** | | | | |
|--------|---------|--|--|--|----------|
| 001601 | 30-360 | | | | 10 10 10 |
| 501600 | 48-2304 | | | | 16 16 16 |



Satellite - 1 Orificio

- Sacapuntas de metal: durabilidad
- Diseño ergonómico



034019

| ref | e/** | | | | |
|--------|--------|--|--|--|-------|
| 034019 | 30-360 | | | | 15 15 |
| 041712 | 32-768 | | | | |
| 041710 | 40-960 | | | | |
| 534019 | 32-768 | | | | 16 16 |



041712

041710

534019

Classic - 1 Orificio

- Sacapuntas de metal: durabilidad



006600



506600

| ref | e/** | | | | |
|--------|---------|--|--|--|--|
| 006600 | 30-360 | | | | |
| 506600 | 20-1600 | | | | |



Classic - 2 Orificios

- Sacapuntas de metal: durabilidad



006700



506700

| ref | e/** | | | | |
|--------|--------|--|--|--|--|
| 006700 | 30-360 | | | | |
| 506700 | 20-800 | | | | |



Compactos

► Una gama de sacapuntas modernos, animados y sobretodo compactos, la solución ideal a la sobrecarga de los estuches de nuestros alumnos

Bulbo - 1 Orificio

- **Ultracompacto:** ideal para el estuche
- **Apertura articulada:** reserva imperdible
- **80% de plástico reciclado post-industrial**
- **Embalaje de cartón reciclable**



007100



507100

ETHIC

| ref | */** | | | | | | |
|--------|---------|--|----|--|----|--|----|
| 007100 | 25-300 | | 8 | | 10 | | 7 |
| 507100 | 30-1080 | | 10 | | 10 | | 10 |



Boogy - 1 Orificio

- **Ultracompacto:** ideal para el estuche
- **Anti-golpes:** materiales resistentes a las caídas
- **Apertura articulada:** reserva imperdible



063310



063311

| ref | */** | | | | | | |
|--------|---------|--|----|--|----|--|----|
| 063310 | 24-288 | | 8 | | 8 | | 8 |
| 063311 | 30-1080 | | 10 | | 10 | | 10 |



Boogy - 2 Orificios

- **Ultracompacto:** ideal para el estuche
- **Anti-golpes:** materiales resistentes a las caídas
- **Apertura articulada:** reserva imperdible



062210



062211

| ref | */** | | | | | | |
|--------|--------|--|---|--|---|--|---|
| 062210 | 25-250 | | 9 | | 8 | | 8 |
| 062211 | 24-864 | | 8 | | 8 | | 8 |



Clásicos

► Igloo y Shaker, dos éxitos de Maped que ilustran la calidad de esta gama de sacapuntas, modernos e imprescindibles

Igloo - 1 Orificio

• El best-seller de los sacapuntas Maped



634754



032191



534754

| ref | e/.. | | | |
|--------|---------|--|--|---|
| 634754 | 25-300 | | | 8 |
| 032191 | 25-300 | | | |
| 534754 | 30-1080 | | | 9 |

| |
|------------------|
| 3 154 146 347547 |
| 3 154 140 321918 |
| 3 154 145 347548 |

Igloo - 1 Orificio - Zurdos

• Especial zurdos: la lámina invertida permite sujetar el lápiz con la mano izquierda y girar en el sentido contrario a las agujas del reloj (movimiento natural de los zurdos)



032210



032211

| ref | e/.. | | | |
|--------|--------|--|--|---|
| 032210 | 25-300 | | | 8 |
| 032211 | 24-864 | | | 8 |

| |
|------------------|
| 3 154 140 322106 |
| 3 154 140 322113 |

Igloo - 2 Orificios

• El best-seller de los sacapuntas Maped



634756



534756

| ref | e/.. | | | |
|--------|--------|--|--|----|
| 634756 | 25-250 | | | 8 |
| 534756 | 30-540 | | | 10 |

| |
|------------------|
| 3 154 146 347561 |
| 3 154 145 347562 |

Igloo Eject - 1 Orificio

- Función **expulsa-mina**: una presión sobre el botón y las minas rotas se retiran con facilidad!



032710



032711

| ref | */** | | | | |
|--------|---------|--|--|--|----------|
| 032710 | 25-300 | | | | 9 8 8 |
| 032711 | 30-1080 | | | | 10 10 10 |



Shaker - 1 Orificio

- Gran capacidad de reserva
- Empuñadura fácil
- El 1% del volumen de negocios dedicada a financiar iniciativas en favor del acceso y el apoyo a la educación



634753



534753

| ref | */** | | | | |
|--------|--------|--|--|--|--------|
| 634753 | 25-300 | | | | 12 5 8 |
| 534753 | 25-750 | | | | 12 5 8 |



Shaker - 2 Orificios

- Gran capacidad de reserva
- Empuñadura fácil
- El 1% del volumen de negocios dedicada a financiar iniciativas en favor del acceso y el apoyo a la educación



634755



035090



534755

| ref | */** | | | | |
|--------|--------|--|--|--|--------|
| 634755 | 25-250 | | | | 12 5 8 |
| 035090 | 25-250 | | | | |
| 534755 | 20-400 | | | | 10 4 6 |





ESCOLAR

Shakky - 1 Orificio

- Diseño lúdico: panda y pingüino
- Gran capacidad de reserva
- Empuñadura fácil



034012



034013



034014

| ref | n/... | | | |
|--------|--------|----|----|------------------|
| 034012 | 25-300 | | | |
| | | 13 | 12 | 3 154 140 340124 |
| 034013 | 25-300 | | | |
| | | 13 | 12 | 3 154 140 340131 |
| 034014 | 25-300 | | | |
| | | 13 | 12 | 3 154 140 340148 |

Tonic Metal - 1 Orificio

- Incluye afiladores de metal: durabilidad
- Reserva transparente



006800



506800

| ref | n/... | | | |
|--------|--------|---|---|------------------|
| 006800 | 20-240 | | | |
| | | 6 | 7 | 7 |
| 506800 | 18-432 | | | |
| | | | | 3 154 145 068009 |

Tonic Metal - 2 Orificios

- Incluye afiladores de metal: durabilidad
- Reserva transparente



006900



506900

| ref | •/•• | | | | |
|--------|--------|--|---|--|---|
| 006900 | 24-120 | | 8 | | 8 |
| 506900 | 18-324 | | | | |



Pulse - 1 Orificio

- Sacapuntas castor
- Un lado opaco y un lado translúcido



071451



071450

| ref | •/•• | | | | |
|--------|--------|--|----|--|----|
| 071451 | 24-288 | | 12 | | 12 |
| 071450 | 28-448 | | 12 | | 12 |



Pulse - 2 Orificios

- Sacapuntas castor
- Un lado opaco y un lado translúcido



071551



071550

| ref | •/•• | | | | |
|--------|--------|--|----|--|----|
| 071551 | 25-250 | | 13 | | 12 |
| 071550 | 25-250 | | 13 | | 12 |



A la moda y lúdicos

► Aprender puede también ser divertido, Maped propone una gama de sacapuntas de calidad con diseño y motivos lúdicos e novedosos

Globe - 1 Orificio

- Depósito de metal
- Un clásico que no pasa de moda

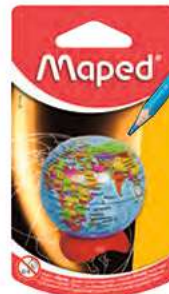

051110



051111

| ref | e/... | | |
|--------|--------|--|--|
| 051110 | 24-240 | | |
| 051111 | 16-192 | | |

Croc Croc Hipo - 1 Orificio

- Reserva de tela extensible: grande o pequeño que se adapta a las necesidades de los niños
- No mancha el estuche
- Diseño lúdico



016610



016611

| ref | e/... | | |
|--------|--------|--|--|
| 016610 | 25-150 | | |
| 016611 | 20-240 | | |

Croc Croc Easy - 1 Orificio

- Apertura fácil del depósito: sistema de pinza
- Diseño lúdico
- Compacto, divertido y fácil de utilizar
- Embalaje de cartón reciclable



018112



018114



018113

| ref | e/... | | |
|--------|--------|--|--|
| 018112 | 24-240 | | |
| 018114 | 24-240 | | |
| 018113 | 24-288 | | |



¡JUNTOS
AFILAMOS EL CAMINO
HACIA EL FUTURO!



Croc Croc - 2 Orificios

- Diseño lúdico
- Gran capacidad de reserva



001700



501700

| ref | */** | | |
|--------|--------|--|-----------------------------|
| 001700 | 25-150 | | 8 8 8 9 3 154 140 017002 |
| 501700 | 18-216 | | 6 6 6 6 3 154 145 017007 |

Croc Croc Twist - 2 Orificios

- Easy twist system: afila los lápices en un abrir y cerrar de ojos
- Diseño de hámster bonito y atractivo
- Sistema de trinquete: permite sacar punta de forma rápida y sencilla



018410



018490



018411

| ref | */** | | |
|--------|--------|--|-----------------------------|
| 018410 | 25-150 | | 8 9 8 8 3 154 140 184100 |
| 018490 | 25-150 | | 3 154 140 184902 |
| 018411 | 12-216 | | 4 4 4 4 3 154 140 184117 |



Croc Croc Innovation - 1 Orificio

- Sistema interactivo patentado: el diente se mueve cuando se saca punta al lápiz si se hace en el sentido correcto
- Reserva importante



017610



017690



017691



017611

| ref | */** | | |
|--------|--------|--|-----------------------------|
| 017610 | 25-150 | | 8 9 8 8 3 154 140 176105 |
| 017690 | 25-150 | | 3 154 140 176907 |
| 017691 | 25-150 | | 3 154 140 176914 |
| 017611 | 20-240 | | 7 7 6 6 3 154 140 176112 |

Croc Croc Signal – 1 Orificio

- Sistema de señal patentado: ¡el sacapuntas que señala el fin de la talla!
- Los ojos se abren cuando el lápiz está afilado

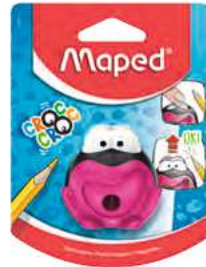

017710



017790



017711

| ref | */** | | | | |
|--------|--------|--|---|---|---|
| 017710 | 25-150 | | 8 | 8 | 9 |
| 017790 | 25-150 | | | | |
| 017711 | 24-288 | | 8 | 7 | 9 |



 3 154140 177102
 3 154140 177904
 3 154140 177119

Croc Croc Universal - 2 Orificios – 4 Diámetros

- Concepto multi afilado único
- Afila 4 tamaños de lápices: clásico Ø 8 mm, jumbo Ø 11 mm, maxi Ø 13 mm y maxi Ø 16 mm
- Este sacapuntas debe ser usado bajo la supervisión de un adulto



017810



017811

| ref | */** | | | | |
|--------|-------|--|--|--|--|
| 017810 | 12-72 | | | | |
| 017811 | 12-72 | | | | |

 3 154140 178109
 3 154140 178116

Ingeniosos

- Limpieza, expulsión de la mina, señal de fin de afilado... son algunas de las funciones que ilustran la gran fuerza innovadora de Maped y que facilitan el uso cotidiano de estos ingeniosos sacapuntas

Clean Grip - 1 Orificio

- Sacapuntas limpio
- Apertura y cierre automáticos del cono con la presión del lápiz
- Comodidad: textura grip para facilitar la empuñadura



014110



014111

| ref | */** | | | | | | | | |
|--------|--------|--|---|---|---|---|---|---|---|
| 014110 | 25-250 | | 5 | 5 | 5 | 5 | 5 | 5 | 5 |
| 014111 | 24-288 | | 5 | 5 | 5 | 4 | 4 | 5 | 5 |

 3 154140 141103
 3 154140 141110

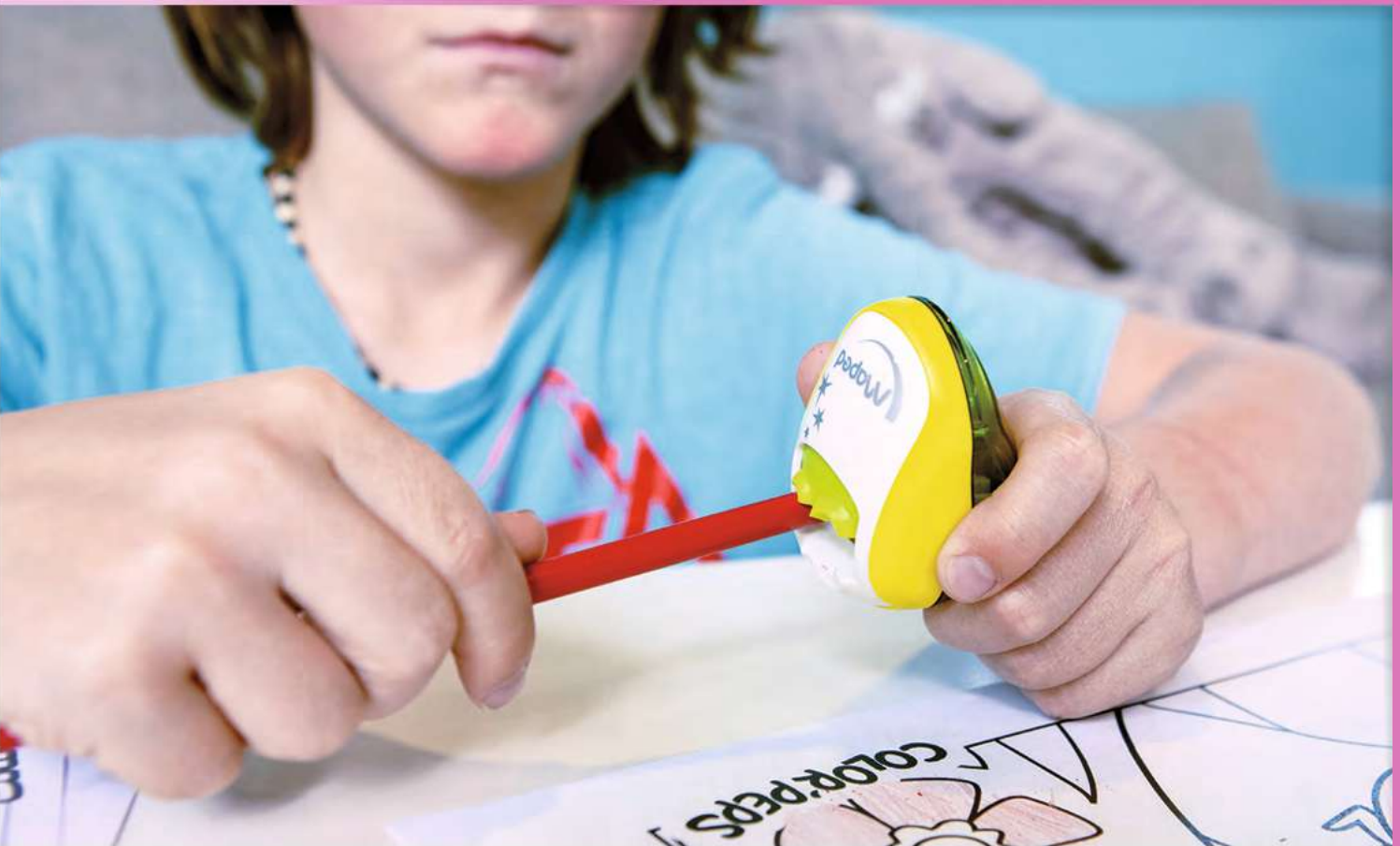

Clean - 1 Orificio

- Sacapuntas limpio
- Tapa de protección de los conos de las cuchillas: no mancha el estuche
- Apertura mediante presión del lápiz y cierre sin manipulación



030110



030111

| ref | e/... | | | | | | | | |
|--------|--------|--|----|--|----|--|----|--|------------------|
| 030110 | 24-288 | | 10 | | 7 | | 7 | | 3 154 140 301101 |
| 030111 | 36-432 | | 14 | | 11 | | 11 | | 3 154 140 301118 |

Clean - 2 Orificios

- Sacapuntas limpio
- Tapa de protección de los conos de las cuchillas: no mancha el estuche
- Apertura mediante presión del lápiz y cierre sin manipulación



030210



030290



030211

| ref | e/... | | | | | | | | | |
|--------|--------|--|----|--|---|--|---|--|------------------|------------------|
| 030210 | 20-200 | | 8 | | 6 | | 6 | | 3 154 140 302108 | |
| 030290 | 20-200 | | | | | | | | | 3 154 140 302900 |
| 030211 | 24-288 | | 10 | | 7 | | 7 | | 3 154 140 302115 | |

Vertical - 2 Orificios

- **Antigolpe:** materiales que resisten las caídas
- **Limpieza:** tapón de protección para evitar los restos de grafito en el estuche



060210



060211

| ref | */** | | | | | | |
|--------|--------|--|---|---|---|--|-----------------|
| 060210 | 24-240 | | 8 | 8 | 8 | | |
| | | | | | | | 3 154140 602109 |
| 060211 | 18-360 | | 6 | 6 | 6 | | |
| | | | | | | | 3 154140 602116 |

Color'Peps - 2 Orificios

- Sacapuntas para lápices de colores
- Afilado redondeado para colorear, subrayar...
- Limpio: tapón protector para evitar restos de virutas en el estuche



043110



043111

| ref | */** | | | | | | |
|--------|--------|--|---|---|---|--|-----------------|
| 043110 | 25-250 | | 9 | 8 | 8 | | |
| | | | | | | | 3 154140 431105 |
| 043111 | 24-288 | | 8 | 8 | 8 | | |
| | | | | | | | 3 154140 431112 |

Galactic - 1 Orificio

- ¡Una presión sobre el botón y las minas rotas se expulsan inmediatamente!
- ¡El sacapuntas que no se atasca!



003701



037090



503700

| ref | */** | | | | | | |
|--------|--------|--|---|---|----|--|-----------------|
| 003701 | 25-250 | | 9 | 6 | 10 | | |
| | | | | | | | 3 154140 037017 |
| 037090 | 25-250 | | | | | | |
| | | | | | | | 3 154140 370909 |
| 503700 | 24-288 | | 9 | 9 | 6 | | |
| | | | | | | | 3 154145 037005 |

Galactic Comfort Pastel - 1 Orificio

- Toque soft para un confort óptimo
- ¡Una presión sobre el botón y las minas rotas se expulsan inmediatamente!
- 3 colores surtidos



| ref | */** | | | | | | |
|--------|--------|--|---|---|---|--|-----------------|
| 037310 | 25-250 | | 9 | 8 | 8 | | |
| | | | | | | | 3 154140 373108 |

DUO Sacapuntas - Goma

► ¡Maped ha inventado una herramienta inteligente para afilar y borrar!
Estos sacapuntas-gomas son ultraeficaces y prácticos y serán rápidamente indispensables!

PVC FREE

Loopy - 1 Orificio

- Sacapuntas no contaminante + goma sin PVC
- Recargable



049110



049111



049120



049121



049130



049190

| ref | e/** | | |
|--------|--------|--|------------------|
| 049110 | 24-144 | | 3 154 140 491109 |
| 049111 | 24-384 | | 3 154 140 491116 |
| 049120 | 24-144 | | 3 154 140 491208 |
| 049121 | 24-384 | | 3 154 140 491215 |
| 049130 | 24-144 | | 3 154 140 491307 |
| 049190 | 24-144 | | 3 154 140 491901 |
| 049131 | 24-384 | | 3 154 140 491314 |
| 049311 | 30-720 | | 3 154 140 493110 |



049131



049311

Connect – 2 Orificios

- Sacapuntas no contaminante + goma sin PVC
- Recargable con la goma Essentials Medium



049210



049220



049211



049221

| ref | */** | | |
|--------|--------|--|-------|
| 049210 | 24-144 | | 8 8 8 |
| 049220 | 24-144 | | 8 8 8 |
| 049211 | 20-320 | | 7 7 6 |
| 049221 | 20-320 | | 7 7 6 |
| 049411 | 36-432 | | |



049411

Connect Pastel – 2 Orificios

- Sacapuntas no contaminante + goma sin PVC
- Recargable con la goma Essentials Medium



049230



049231

| ref | */** | | |
|--------|--------|--|-------|
| 049230 | 24-144 | | 8 8 8 |
| 049231 | 20-320 | | 7 6 7 |



Expositor de mostrador - Pastel

- Entrega lleno
- Material : cartón
- Las dimensiones vienen indicadas para un display montado
- Características: anchura 384 mm, profundidad 263 mm, altura 285 mm
- Incluye 1 cartela extraíble
- Hasta finales de stocks



| ref | •/•• | | |
|--------|------|--|--|
| 993416 | 1-48 | 88 piezas x24 EAN 315414 851730 6 x13 EAN 315414 742546 6 x12 EAN 315414 484211 2 x24 EAN 315414 049231 1 x15 EAN 315414 123211 4 |  3 154149 934164 |

Eléctrico

- ▶ Sacapuntas eléctrico para lápices de diámetro estándar

Office

- ▶ Maped, líder mundial en sacapuntas, dispone también de una oferta dedicada al mundo de la oficina: diseño moderno y calidad impecable



Turbo Twist 2.0

- Rápido y fácil de usar
- Compacto y estable
- Funciona con 4 pilas AA LR6 (no incluidas)



Advanced - 1 Orificio

- Incluye afiladores de metal: durabilidad
- Hasta finales de stocks



| ref | •/•• | | |
|--------|------|---|--|
| 027330 | 6-72 |  |  3 154140 273309 |

| ref | •/•• | | |
|--------|-------|---|--|
| 067510 | 9-162 |  |  3 154140 675103 |

Clásicas

- ▶ Gomas con formas clásicas para una eficacia máxima o un uso técnico
- ▶ La composición de todas estas gomas carece de Ftalatos. La mayoría de los productos no contienen PVC

PHTHALATE
FREE

Technic Ultra

- Goma bimaterial: alta eficacia y aspecto firme
- Función Dust Free: menos residuo como una goma sin esta función
- Funda de cartón
- Ancho 21.5 mm, profundidad 12 mm, altura 61 mm

MADE IN
FRANCE

PVC
FREE



116412



116411

| ref | */** | |
|--------|--------|--|
| 116412 | 30-360 | x2 |
| | |  |
| 116411 | 20-480 | |
| | |  |

Mini Technic Ultra sin funda

- Goma bimaterial: alta eficacia y aspecto firme
- Función Dust Free: menos residuo como una goma sin esta función
- Mini formato, especial para el estuche
- Ancho 18.2 mm, profundidad 12.6 mm, altura 39 mm

MADE IN
FRANCE

PVC
FREE



106419



106411



Mini Technic Ultra

- Goma bimaterial: alta eficacia y aspecto firme
- Función Dust Free: menos residuo como una goma sin esta función
- Mini formato, especial para el estuche
- Funda de cartón
- Ancho 17.8 mm, profundidad 12.3 mm, altura 39 mm

MADE IN
FRANCE

PVC
FREE



106712



106711

| ref | */** | |
|--------|--------|---|
| 106419 | 15-105 | x9 |
| | |  |
| 106411 | 36-864 | |
| | |  |

| ref | */** | |
|--------|--------|---|
| 106712 | 30-360 | x2 |
| | |  |
| 106711 | 36-864 | |
| | |  |

Technic 600 Premium

- **Formulación:** alta eficiencia y sin pvc
- **Función Dust Free:** menos residuo como una goma sin esta función
- **Funda de cartón**
- **Ancho 21.8 mm, profundidad 12 mm, altura 61 mm**



115910



115911



115912

| ref | n/° | | |
|--------|--------|----|--|
| 115910 | 30-360 | x1 | |
| 115911 | 30-360 | x2 | |
| 115912 | 18-108 | x4 | |

Technic 600

- **Eficacia demostrada**
- **Función Dust Free:** menos residuo como una goma sin esta función
- **Funda de cartón y envase de celofán en expositor**
- **Ancho 21.8 mm, profundidad 12 mm, altura 61 mm**



011722



011724



011600

| ref | n/° | | |
|--------|--------|----|--|
| 011722 | 30-360 | x2 | |
| 011724 | 18-108 | x4 | |
| 011600 | 20-480 | | |

Technic 300

- **Eficacia demostrada**
- **Función Dust Free:** menos residuo como una goma sin esta función
- **Mini formato:** especial para el estuche
- **Funda de cartón y envase de celofán**
- **Ancho 17.8 mm, profundidad 12,3 mm, altura 39 mm**



| ref | n/° | | |
|--------|--------|--|--|
| 011301 | 36-864 | | |

Mini Technic

- Eficacia demostrada
- Mini formato: especial para el estuche
- Envase de celofán
- Ancho 18.2 mm, profundidad 12.6 mm, altura 39 mm



011305

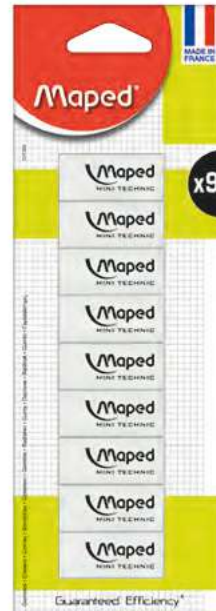

011309



011300

| ref | */** | | |
|--------|--------|----|--|
| 011305 | 30-360 | x3 | |
| 011309 | 15-105 | x9 | |
| 011300 | 36-864 | | |

Pulse

- Poder de borrado eficaz
- Protegida con un embalaje de celofán
- Perfecto para uso escolar
- Ancho 21.8 mm, profundidad 12 mm, altura 61 mm



116052



116050

| ref | */** | | |
|--------|--------|----|--|
| 116052 | 30-360 | x2 | |
| 116050 | 20-480 | | |

Mini Pulse

- Poder de borrado eficaz
- Protegida con un embalaje de celofán
- Perfecto para uso escolar
- Mini formato: especial para el estuche
- Ancho 18.2 mm, profundidad 12.7 mm, altura 39 mm



113053



113050

| ref | */** | | |
|--------|--------|----|--|
| 113053 | 30-360 | x3 | |
| 113050 | 36-864 | | |

Technic Duo

- Dos usos
- Lado blanco: lápiz y mina de grafito
- Lado azul: tinta
- Ancho 17.6 mm, profundidad 12.1 mm, altura 39 mm



ref

511710 36-864



3 154 145 117103

Technic 600 Green

- Eficacia demostrada
- Función Dust Free: menos residuo como una goma sin esta función
- Funda de cartón y envase de celofán
- Ancho 21.8 mm, profundidad 12 mm, altura 61 mm



ref

115920 20-480



3 154 141 159206

Greenlogic

- Hecho en Francia
- Ergonómica : precisión y comodidad
- Embalaje de papel reciclable
- Ancho 20.6 mm, profundidad 16 mm, altura 60 mm



ref

116610 30-360 x2



3 154 141 166105

Softy

- Textura suave: borrado agradable
- Funda de cartón y envase de celofán en expositor
- Ancho 23.2 mm, profundidad 12.6 mm, altura 56 mm



021792



511790

| ref | */** | | |
|--------|--------|----|--|
| 021792 | 30-360 | x2 | |
| 511790 | 20-480 | | |

Mini Softy

- Textura suave: borrado agradable
- Mini formato, especial para el estuche
- Funda de cartón y envase de celofán en expositor
- Ancho 18 mm, profundidad 12.5 mm, altura 39 mm



021789



012403

| ref | */** | | |
|--------|--------|--------|--|
| 021789 | 30-360 | x2 | |
| 012403 | 30-360 | x2 + 1 | |
| 511780 | 36-864 | | |



511780

Epure

- Eficacia, comodidad y suavidad
- Ancho 27 mm, profundidad 11 mm, altura 61 mm



103700



103701

| ref | */** | | |
|--------|--------|----------------------------|--|
| 103700 | 24-144 | x2 | |
| 103701 | 20-480 | x20 Embalaje de celofán | |

Protección

- ▶ Gomas con un estuche de plástico para una protección más eficaz y duradera
- ▶ La composición de todas estas gomas carece de ftalatos y/o PVC



Technic Ultra protección

- Funda plástica bimaternal
- Goma de dos materiales: alta eficacia
- Se recarga con el Technic Ultra de Maped



120510



120511

Architecte

- Funda translúcida y ergonómica
- Goma ancha para un borrado completo



011010



511010

| ref | n/° | | | |
|-------------------|--------|--|--|-------|
| 120510 | 32-320 | | | 16 16 |
| 3 154 141 205 101 | | | | |
| 120511 | 20-240 | | | 10 10 |
| 3 154 141 205 118 | | | | |

| ref | n/° | | | | | |
|-------------------|--------|--|--|--|----------|--|
| 011010 | 30-360 | | | | 10 10 10 | |
| 3 154 140 110 109 | | | | | | |
| 511010 | 16-288 | | | | 6 5 5 | |
| 3 154 145 110 104 | | | | | | |

Precision

- Precisión de borrado: goma de plástico duro
- Funda ergonómica texturizada



021109



112513

| ref | n/° | | | | |
|-------------------|--------|--|--|-------|--------|
| 021109 | 30-360 | | | 15 15 | |
| | | | | | x2 |
| 3 154 140 211 097 | | | | | |
| 112513 | 30-120 | | | 15 15 | |
| | | | | | x2 + 1 |
| 3 154 141 125 133 | | | | | |
| 511100 | 24-720 | | | 12 12 | |
| 3 154 145 111 002 | | | | | |



511100

Zenoa Plus

- Estuche de protección rotativo: goma 100% protegida
- Apertura máxima del estuche de protección para un uso óptimo
- Modelo Maped ultra-diseño

PVC
FREE

123210



123290



123211

| ref | */** | | | | |
|--------|--------|---|---|---|------------------|
| 123210 | 25-300 | | | | |
| | | 8 | 8 | 9 | 3 154 141 232107 |
| 123290 | 25-300 | | | | |
| | | | | | 3 154 141 232909 |
| 123211 | 15-240 | | | | |
| | | 5 | 5 | 5 | 3 154 141 232114 |

Zenoa

- ¡El original!
- Estuche de protección rotativo: goma 100% protegida

PVC
FREE

011320



113290



511320

| ref | */** | | | | |
|--------|--------|----|---|----|------------------|
| 011320 | 25-300 | | | | |
| | | 10 | 5 | 10 | 3 154 140 113209 |
| 113290 | 25-300 | | | | |
| | | | | | 3 154 141 132902 |
| 511320 | 20-240 | | | | |
| | | 8 | 4 | 8 | 3 154 145 113204 |

Diseño

- ▶ Gomas originales y lúdicas que combinan ergonomía y estética
- ▶ La composición de todas estas gomas carece de Ftalatos y no contienen PVC

PVC
FREEPHTALATE
FREE

Croc Croc Goma Maleable

- Goma maleable: se amasa, se estira, se divide en trozos pequeños ¡y nunca se estropea!
- Borrado eficaz
- Caja de protección de plástico translúcido con cierre



NEW!

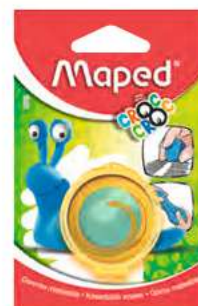

| ref | */** | | | | |
|--------|--------|--|--|------------------|------------------|
| 014501 | 20-120 | | | | |
| | | | | x1 goma + 1 caja | 3 154 140 145019 |



Goma Squeeze Mini Cute

- **Efecto apriétame:** la primera goma que se presiona para un efecto relajante
- **Lúdico:** gomas de colores con diseño divertido y atractivo
- **Borrado:** toda la goma sirve para borrar



| ref | e/... | | | | |
|--------|--------|--|--|--|--|
| 015501 | 25-300 | | | | |
| 015503 | 25-300 | | | | |
| 015502 | 16-192 | | | | |

Bolsa plástica de protección

3 154 140 155018

3 154 140 155032

3 154 140 155025

Croc Croc Puzzle

- **Lúdico:** ¡nuevas gomas puzzle de la colección Croc Croc! Gomas de borrar de 3 partes que encajan y se desencajan entre sí para mayor diversión
- **Ergonomía:** forma adaptada a las manos de los niños, agarre cómodo
- **2 usos:** borran el grafito y la tinta sensible a la fricción



| ref | e/... | | | | |
|--------|--------|--|--|--|--|
| 015801 | 30-360 | | | | |
| 015901 | 30-360 | | | | |
| 015802 | 20-400 | | | | |

3 154 140 158019

3 154 140 159016

3 154 140 158026

Little Monster

- **Lúdico:** gomas Mini Technic decoradas, 4 fundas en forma de monstruos con colores a juego
- **Ergonomía:** forma adaptada a las manos de los niños, agarre cómodo
- **Mini formato, especial para el estuche**
- **Recarga:** Mini Technic o T300



127710



127711

| ref | */** | | | | | | |
|--------|--------|--|----|--|----|--|----|
| 127710 | 30-360 | | 10 | | 10 | | 10 |
| 127711 | 20-320 | | 8 | | 6 | | 6 |



Ergo Fun

- **Ergonomía:** forma adaptada a las manos de los niños, agarre cómodo
- **Precisión de borrado:** permite borrar fino o ancho
- **Lúdico:** gomas coloridas con formas de animales para coleccionar



119002



119001

| ref | */** | | | | | | |
|--------|--------|----------------------|---|--|---|--|---|
| 119002 | 12-144 | | 3 | | 3 | | 3 |
| | | 4 modelos existentes | | | | | |
| 119001 | 24-576 | | 6 | | 6 | | 6 |



Essentials Soft

- Eficacia, ergonomía y suavidad
- Pequeño formato



112911



992428

| ref | */** | | | |
|--------|--------|---|--|--|
| 112911 | 40-800 | | | |
| 992428 | -6000 | Bolsa de plástico. Se puede juntar. Entregada vacía. Contiene entre 1 y 3 gomas | | |



Essentials Soft - Pastel

- Eficacia, ergonomía y suavidad
- Surtido con 3 colores pastel de moda
- Pequeño formato



| ref | */** | | | | | | |
|--------|--------|--|----|--|----|--|----|
| 112921 | 40-800 | | 14 | | 13 | | 13 |



Essentials Soft - Medium

- Recargable Duo sacapuntas-lápiz- goma Connect
- Eficacia, ergonomía y suavidad
- Formato medium



| ref | */** | | Barcode |
|--------|--------|--|-------------------|
| 049411 | 36-432 | | 3 154 140 494 117 |

Essentials Soft - Ancho

- Eficacia, ergonomía y suavidad
- Gran formato



| ref | */** | | Barcode |
|--------|--------|--|-------------------|
| 122811 | 20-400 | | 3 154 141 228 117 |

ESCOLAR

Caucho natural

- ▶ Gomas de caucho natural, obtenido de la savia del árbol hevea
- ▶ Bordes biselados (salvo Rembrandt y Miga de Pan): para un borrado preciso
- ▶ La composición de todas estas gomas carece de Ftalatos y PVC



Dessin - Mediano

- Hecho en Francia
- Ancho 18 mm, profundidad 8.8 mm, altura 54 mm
- FSC Mix
- Embalaje de papel reciclable



020612FM

010013FM

| ref | */** | | Barcode |
|----------|--------|----|-------------------|
| 020612FM | 30-360 | x2 | 3 154 140 206 123 |
| 010013FM | 40-720 | | 3 154 140 100 131 |

Dessin - Ancho

- Hecho en Francia
- Ancho 21.5 mm, profundidad 11 mm, altura 65 mm
- FSC Mix
- Embalaje de papel reciclable



010715FM

010716FM

| ref | */** | | Barcode |
|----------|--------|-----------------------------|-------------------|
| 010715FM | 30-360 | x1 | 3 154 140 107 154 |
| 010716FM | 30-360 | x1 Duo-Gom + 1 Dessin ancho | 3 154 140 107 161 |

Duo-Gom - Mediano

- Hecho en Francia
- Lado rosa: lápiz y mina de grafito
- Lado azul: tinta
- Ancho 18 mm, profundidad 9 mm, altura 55 mm
- FSC Mix
- Embalaje de papel reciclable



010762FM



010033FM

| ref | */** | | |
|----------|--------|----|--|
| 010762FM | 30-360 | x2 | |
| 010033FM | 40-720 | | |

Duo-Gom - Ancho

- Hecho en Francia
- Lado rosa: lápiz y mina de grafito
- Lado azul: tinta
- Ancho 21.5 mm, profundidad 11 mm, altura 65 mm
- FSC Mix
- Embalaje de papel reciclable



010710FM



010030FM

| ref | */** | | |
|----------|--------|--|--|
| 010710FM | 30-360 | | |
| 010030FM | 20-480 | | |

Rembrandt

- Hecho en Francia
- Extra ancha
- Ancho 35 mm, profundidad 12 mm, altura 52 mm
- FSC Mix
- Embalaje de papel reciclable



| ref | */** | | |
|----------|--------|--|--|
| 010725FM | 30-360 | | |

Miga de pan

- Hecho en Francia
- Para uso de los aficionados y de los profesionales de Bellas Artes
- Puede cortarse y modelarse
- Borra y difumina pastel y carboncillo
- Caja de plástico de protección con cierre



| ref | */** | | |
|--------|--------|--|--|
| 010450 | 18-432 | | |

Utensilios para borrar

- ▶ Las gomas están siempre protegidas
- ▶ La composición de todas estas gomas carece de ftalatos y PVC



Gom-Pen

- Presión soft para más confort
- Sección triangular para una presión óptima
- Recorte cilíndrico: Ø 6.75 mm
- Cursor de autobloqueo



012511

512511



512500

| ref | */** | | |
|--------|--------|-------------------|--|
| 012511 | 25-250 | x1 + 1 recarga | |
| 512511 | 12-696 | Bolsa x2 recargas | |
| 512500 | 15-870 | | |

Universal Gom Stick Pastel

- Diseño exclusivo Maped: recargable con una goma de formato estándar (Technic 600)
- Surtido con 3 colores pastel de moda



122010



122011

| ref | */** | | |
|--------|--------|------------|--|
| 122010 | 32-320 | 10 11 11 | |
| 122011 | 20-240 | 6 7 7 | |

Universal Gom Stick

- Diseño exclusivo Maped: recargable con una goma de formato estándar (Technic 600)



012000



512000

| ref | */** | | |
|--------|--------|-----------|--|
| 012000 | 32-320 | 12 8 12 | |
| 512000 | 20-240 | 8 4 8 | |
| 122090 | 32-320 | | |
| 122091 | 32-320 | | |



122090



122091

Classico

- ▶ **Marcado de alta calidad:** impresión de las graduaciones con una tinta UV para una resistencia óptima
- ▶ **Presentación:** inners decorados (salvo kits)
- ▶ **Envase:** bolsa de protección individual colgable
- ▶ **Personalización:** espacio para escribir el nombre

Reglas



146507



146112



146119

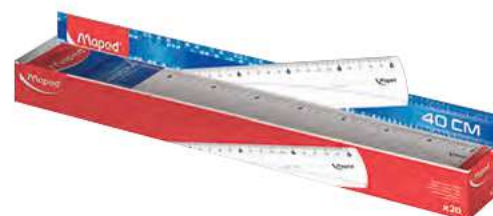

146114

| ref | */** | | |
|--------|---------|----------------------------|--|
| 146507 | 25-2000 | 15 cm Doble graduación | |
| 146112 | 30-1020 | 20 cm Doble graduación | |
| 146119 | 25-500 | 30 cm Doble graduación | |
| 146114 | 20-240 | 40 cm Borde antimanchas | |
| 146115 | 20-240 | 50 cm Borde antimanchas | |

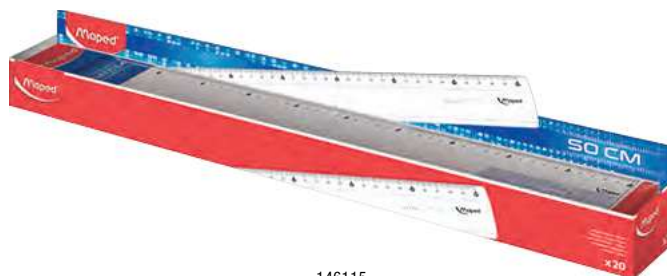

146115

Decímetros



146108

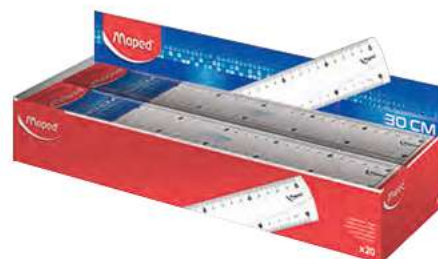

146109

| ref | */** | | |
|--------|--------|------------------|--|
| 146108 | 20-600 | Doble decímetro | |
| 146109 | 20-360 | Triple decímetro | |

Escuadra 45°

- 0 situado en el ángulo recto
- Borde anti manchas
- Doble graduación

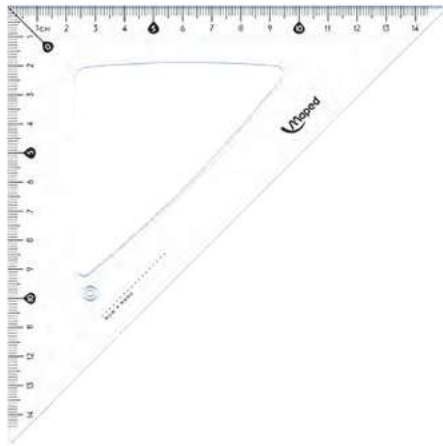

| ref | •/•• | | |
|--------|--------|------------------|---|
| 146123 | 20-800 | Hipotenusa 21 cm |  |

Cartabones 60°

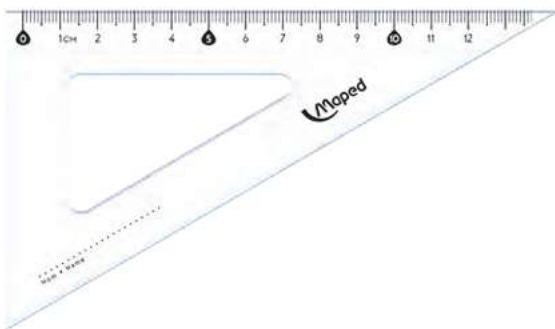

- Borde anti manchas



146120



146122

| ref | •/•• | | |
|--------|---------|--|---|
| 146120 | 20-1400 | Lado mayor 15 cm |  |
| 146122 | 20-720 | Lado mayor 21 cm 0 situado en el ángulo recto |  |

Transportador 180°



| ref | •/•• | | |
|--------|--------|------------|---|
| 146134 | 20-800 | Base 12 cm |  |

Mini kit 4 piezas

- 1 regla de 15 cm
- 1 cartabón 60°/12 cm + 1 escuadra 45°/12 cm
- 1 transportador de 180°/10 cm

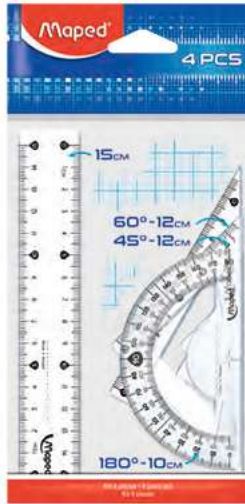

| ref | */** | Barcode |
|--------|---------|------------------|
| 242815 | 100-400 | 3 154 142 428158 |

Kit 3 Piezas - 4 Funciones

- 1 regla de 30 cm
- 1 escuadra 2 en 1 (60° y 45°)
- 1 transportador de 180°/12 cm



| ref | */** | Barcode |
|--------|--------|------------------|
| 897121 | 40-120 | 3 154 148 971214 |

Medium kit 4 piezas

- 1 regla de 20 cm
- 1 cartabón 60°/21 cm + 1 escuadra 45°/21 cm
- 1 transportador de 180°/10 cm

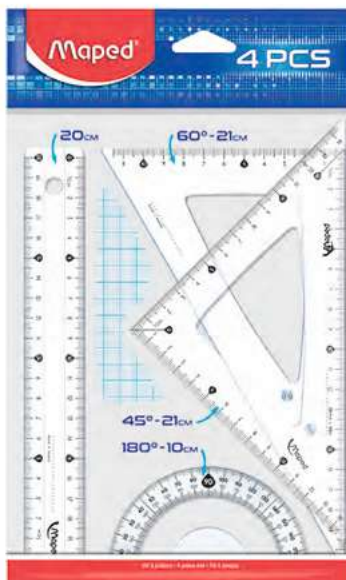

| ref | */** | Barcode |
|--------|--------|------------------|
| 242820 | 24-288 | 3 154 142 428202 |

Maxi kit 4 piezas

- 1 regla de 30 cm
- 1 cartabón 60°/21 cm + 1 escuadra 45°/21 cm
- 1 transportador 180°/12 cm

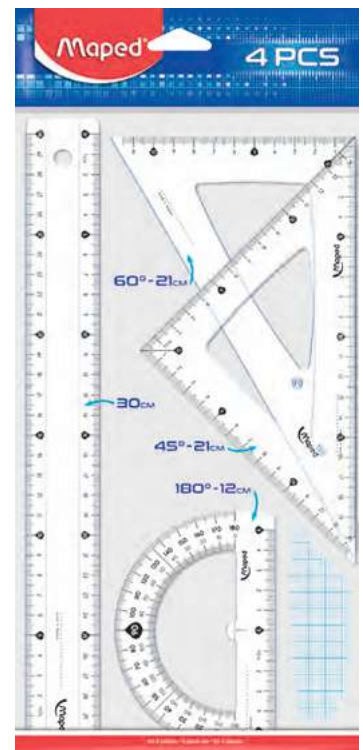

| ref | */** | Barcode |
|--------|--------|------------------|
| 242830 | 24-144 | 3 154 142 428301 |

Geometric

- ▶ Herramientas fabricadas de materiales reciclados
- ▶ Diseño ergonómico y técnico
- ▶ Marcado de alta calidad: impresión de las graduaciones con tinta UV para una resistencia óptima
- ▶ Envase: bolsa de protección individual colgable

Geometric - Reglas

- Borde antimanchas
- Empuñadura ergonómica
- Herramientas fabricadas con un 80% de materiales reciclados
- Embalaje de papel reciclable



| ref | •/•• | | |
|--------|--------|----------------|-------------|
| 242020 | 25-500 | 20 cm | |
| 242030 | 25-200 | 30 cm | |
| 242040 | 20-240 | 40 cm | |
| 254330 | 25-200 | 30 cm - Zurdos | NEW! |



242020



242030



242040



254330



ESCOLAR

Geometric - Decímetros

- Doble graduación
- Empuñadura ergonómica
- Herramientas fabricadas con un 80% de materiales reciclados
- Embalaje de papel reciclable



| ref | •/•• | | |
|--------|--------|------------------|--|
| 242120 | 20-240 | Doble decímetro | |
| 242130 | 20-200 | Triple decímetro | |



242120



242130



Geometric - Escuadras 45°

- 0 situado en el ángulo recto: para medir y trazar a la vez
- Empuñadura ergonómica (salvo el modelo 32 cm)
- Herramientas fabricadas con un 80% de materiales reciclados
- Embalaje de papel reciclable*

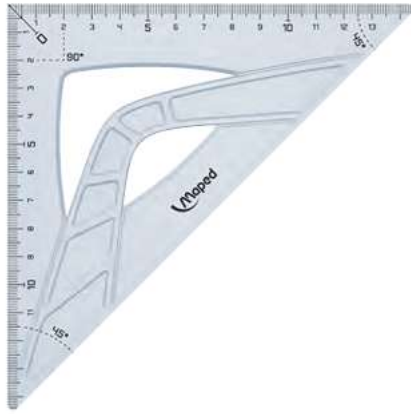

242421



ETHIC

147527



242426



| ref | */** | | |
|--------|--------|---|--|
| 242421 | 30-360 | Hipotenusa 21 cm *Disponible únicamente para esta referencia | |
| 242426 | 20-180 | Hipotenusa 26 cm | |
| 147527 | 10-120 | Hipotenusa 32 cm | |

Geometric - Escuadras 60°

- 0 situado en el ángulo recto: para medir y trazar a la vez
- Empuñadura ergonómica (salvo el modelo 32 cm)
- Herramientas fabricadas con un 80% de materiales reciclados
- Embalaje de papel reciclable*

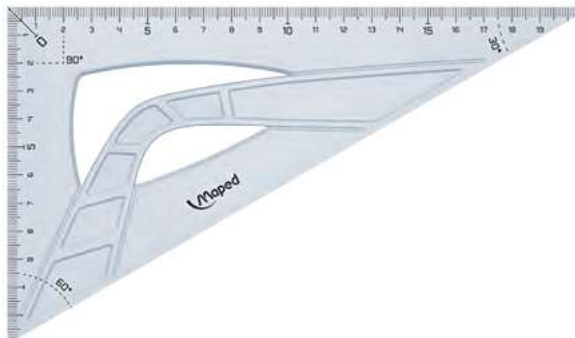

242621



ETHIC

147526



242626



| ref | */** | | |
|--------|--------|---|--|
| 242621 | 20-200 | Lado mayor 21 cm *Disponible únicamente para esta referencia | |
| 242626 | 20-400 | Lado mayor 26 cm | |
| 147526 | 10-120 | Lado mayor 32 cm | |

Geometric - Transportador 180°



- Indicación optimizada del centro
- Empuñadura ergonómica
- Señalización del sentido de lectura de las graduaciones
- Herramientas fabricadas con un 80% de materiales reciclados
- Embalaje de papel reciclable

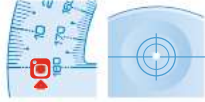

| ref | ●/●● | | |
|--------|--------|------------|---|
| 242180 | 30-360 | Base 12 cm |  |

Geometric - Transportador 360°



- Indicación optimizada del centro
- Empuñadura ergonómica
- Señalización del sentido de lectura de las graduaciones
- Herramientas fabricadas con un 80% de materiales reciclados
- Embalaje de papel reciclable



| ref | ●/●● | | |
|--------|--------|----------------|---|
| 242360 | 20-400 | Diámetro 12 cm |  |

Geometric - Kit de 3 Piezas - Zurdos



- 1 regla de 30 cm
- 1 escuadra 45°/21 cm
- 1 transportador 180°/12 cm
- Herramientas fabricadas con un 80% de materiales reciclados
- Embalaje de cartón reciclable



| ref | ●/●● | | |
|--------|-------|--|---|
| 897118 | 20-80 | |  |

Geometric - Maxi kit 4 piezas



- 1 regla de 30 cm
- 1 cartabón 60°/21 cm + 1 escuadra 45°/21 cm
- 1 transportador 180°/12 cm
- Herramientas fabricadas con un 80% de materiales reciclados
- Embalaje de cartón reciclable

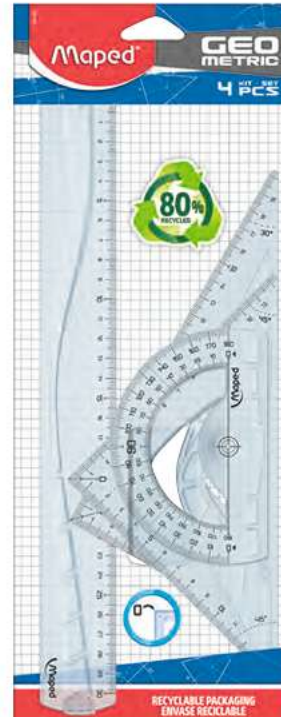

| ref | ●/●● | | |
|--------|-------|--|---|
| 242767 | 24-96 | |  |

Trend & Ludique

► Porque también se puede aprender divirtiéndose, Maped ofrece un surtido de reglas ideal para aprender a trazar

Croc Croc - Regla plegable

- Fácil de usar para medir, subrayar o dibujar
- Trazo continuo perfecto con el bloqueo de la regla en posición abierta
- Fácil de abrir y de cerrar
- Tamaño ideal para meter en un estuche
- Embalaje de cartón reciclable



NEW!

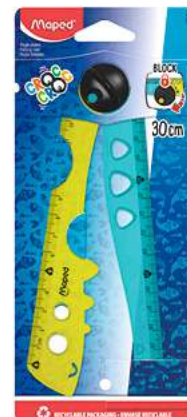

ref **
282030 18-360  15 cm/30 cm



3 154 142 820303



Kidy'Grip - Regla

- Ergonómica: material antideslizante para una estabilidad perfecta
- Material resistente a los choques
- Lúdica: formas y dibujos
- Material resistente a los choques



ref **
278710 20-240  9 6 5 20 cm



3 154 142 787101

Kidy'Grip - Decímetros

- Ergonómica: material antideslizante para una estabilidad perfecta
- Graduaciones más grandes y legibles
- Lúdica: formas y dibujos
- Material resistente a los choques



278610



278611

ref **
278610 20-240  9 6 5 Triple decimetro cm



3 154 142 786104

278611 12-144  6 3 3 Triple decimetro cm/pulgadas



3 154 142 786111



Twist'n Flex

- ▶ Hecho de material flexible, irrompible y lúdico, ¡Twist'n Flex puede doblarse infinitamente!
- ▶ Atractivo: un motivo valorizador e impactante en el lineal
- ▶ Funda: bolsa de protección colgable
- ▶ No tiene ftalatos
- ▶ Presentación: inners decorados



Twist'n Flex Decor - Reglas

- ¡"Twist'n Flex The Original" se convierte en una versión aún más divertida!
- Doble graduación



| ref | •/•• | | |
|--------|--------|------------|-----------------|
| 279115 | 20-200 | 5 5 5 5 | 3 154142 791153 |
| 279215 | 20-200 | 5 5 5 5 | 3 154142 792150 |
| 279315 | 20-200 | 5 5 5 5 | 3 154142 793157 |

279115

279215

279315

Twist'n Flex Original - Reglas

- Doble graduación



| ref | */** | | | | |
|--------|--------|--|-------|-------------------|------------------|
| 279110 | 20-200 | | 8 8 4 | 15 cm | 3 154 142 791108 |
| 279190 | 20-200 | | | 15 cm | 3 154 142 791900 |
| 279210 | 20-200 | | 8 8 4 | 20 cm | 3 154 142 792105 |
| 279290 | 20-200 | | | 20 cm | 3 154 142 792907 |
| 027900 | 20-200 | | 8 8 4 | 30 cm | 3 154 140 279004 |
| 279390 | 20-200 | | | 30 cm | 3 154 142 793904 |
| 279010 | 20-200 | | 8 8 4 | 30 cm/12 pulgadas | 3 154 142 790101 |



279110 279190 279210 279290



027900 279390 279010

Twist'n Flex Original - Escuadra 60°



| ref | */** | | | | |
|--------|--------|--|-------|------------------|------------------|
| 279410 | 20-420 | | 8 8 4 | Hipotenusa 15 cm | 3 154 142 794109 |

Twist'n Flex Original - Transportador 180°



| ref | */** | | | | |
|--------|--------|--|-------|------------|------------------|
| 279810 | 20-420 | | 8 8 4 | Base 10 cm | 3 154 142 798107 |

Twist'n Flex Original - Mini kit 3 piezas

- 1 regla de 15 cm
- 1 cartabón 60°/15 cm
- 1 transportador 180°/10 cm



| | | | |
|--------|--------|---------|------------------|
| ref | e/.. | | |
| 895024 | 10-200 | 4 4 2 | 3 154 148 950240 |

Twist'n Flex Original - Medium kit 4 piezas

- 1 regla de 20 cm
- 1 cartabón 60°/21 cm
- 1 escuadra 45°/21 cm
- 1 transportador 180°/12 cm



| | | | |
|--------|--------|---------|------------------|
| ref | e/.. | | |
| 897158 | 20-100 | 8 8 4 | 3 154 148 971580 |

Twist'n Flex Original - Maxi kit 3 piezas

- 1 regla de 30 cm
- 1 cartabón 60°/21 cm
- 1 transportador 180°/12 cm



| | | | |
|--------|--------|---------|------------------|
| ref | e/.. | | |
| 895055 | 20-120 | 8 8 4 | 3 154 148 950554 |

Twist'n Flex Original - Maxi kit 4 piezas

- 1 regla de 30 cm
- 1 cartabón 60°/21 cm
- 1 escuadra 45°/21 cm
- 1 transportador 180°/12 cm



| | | | |
|--------|--------|---------|------------------|
| ref | e/.. | | |
| 897157 | 20-100 | 8 8 4 | 3 154 148 971573 |

Twist'n Flex Pulse - Reglas

- Doble graduación
- Material flexible
- Diseño único



| ref | */** | | | |
|--------|--------|--|--|---|
| 278810 | 20-200 |  10 |  10 |  |
| | | 15 cm | | 3 154142 788108 |
| 278910 | 20-200 |  10 |  10 |  |
| | | 20 cm | | 3 154142 789105 |
| 279710 | 20-200 |  10 |  10 |  |
| | | 30 cm | | 3 154142 797100 |
| 279711 | 20-200 |  10 |  10 |  |
| | | 30 cm/pulgadas | | 3 154142 797117 |



278810

278910

279710

279711

Twist'n Flex Pulse - Maxi Set 4 piezas

- 1 regla 30 cm
- 1 escuadra 60°/21 cm
- 1 escuadra 45°/21 cm
- 1 transportador 180°/12 cm



| ref | */** | | | |
|--------|--------|--|--|---|
| 981722 | 20-100 |  10 |  10 |  |
| | | | | 3 154149 817221 |

Study Unbreakable

Study Unbreakable - Reglas

- **Material irrompible:** los producto soportan la flexión y los golpes en la cartera sin romperse
- Disponible en el idioma local bajo ciertas condiciones
- Doble graduación



245310 245410 245610 245611



245312 245412 245612

| ref | n/° | | | |
|--------|--------|-------------------|----|-------------------|
| 245310 | 25-800 | 10 15 cm | 15 | 3 154 142 453 105 |
| 245410 | 25-500 | 10 20 cm | 15 | 3 154 142 454 102 |
| 245610 | 25-250 | 10 30 cm | 15 | 3 154 142 456 106 |
| 245611 | 25-250 | 10 12 pulgadas | 15 | 3 154 142 456 113 |
| 245312 | 25-800 | 10 15 cm | 15 | 3 154 142 453 129 |
| 245412 | 25-500 | 10 20 cm | 15 | 3 154 142 454 126 |
| 245612 | 25-250 | 10 30 cm | 15 | 3 154 142 456 120 |

Study Unbreakable - Reglas

- **Material irrompible:** los productos pueden soportar flexiones y golpes en la mochila sin llegar a romperse
- Reglas transparentes
- Doble graduación



245320 245420 245620

| ref | n/° | | | |
|--------|--------|----------------------|--|-------------------|
| 245320 | 25-800 | 15 cm - Transparente | | 3 154 142 453 204 |
| 245420 | 25-500 | 20 cm - Transparente | | 3 154 142 454 201 |
| 245620 | 25-250 | 30 cm - Transparente | | 3 154 142 456 205 |

Study Unbreakable - Medium Kit 4 piezas

- 1 regla de 20 cm
- 1 cartabón 60°/21 cm
- 1 escuadra 45°/21 cm
- 1 transportador 180°/12 cm



981703



981705



981707

| ref | */** | | |
|--------|--------|--------------------------------------|-----------------------|
| 981703 | 24-288 | 12 20 cm | 12 3 154149 817030 |
| 981705 | 24-288 | 12 20 cm/8 pulgadas | 12 3 154149 817054 |
| 981707 | 24-288 | 12 20 cm/8 pulgadas - Ref Español | 12 3 154149 817078 |

Study Unbreakable - Maxi kit 4 piezas

- 1 regla de 30 cm
- 1 cartabón 60°/21 cm
- 1 escuadra 45°/21 cm
- 1 transportador 180°/12 cm



981701



981704



981706

| ref | */** | | |
|--------|--------|--------------------------------------|-----------------------|
| 981701 | 24-144 | 12 30 cm | 12 3 154149 817016 |
| 981704 | 24-144 | 12 30 cm/12 pulgadas | 12 3 154149 817047 |
| 981706 | 24-144 | 12 30cm/12 pulgadas - Ref Español | 12 3 154149 817061 |

Study Unbreakable - Herramientas

- **Material irrompible:** los productos pueden soportar flexiones y golpes en la mochila sin llegar a romperse
- **Doble graduación**



245421



236110



245631



236210



611411



245710



245801



245910

| ref | ●/●● | | |
|--------|--------|-------------------------------------|-----------------|
| 245421 | 24-500 | 24 20 cm | 3 154142 454218 |
| 236110 | 30-600 | Doble decímetro | 3 154142 361103 |
| 245631 | 25-250 | 25 30 cm | 3 154142 456311 |
| 236210 | 30-450 | Triple decímetro | 3 154142 362100 |
| 611411 | 30-720 | 60°/15 cm | 3 154146 114118 |
| 245710 | 30-720 | 45°/21 cm | 3 154142 457103 |
| 245801 | 30-600 | 60°/21 cm | 3 154142 458018 |
| 245910 | 30-540 | 1 transportador 180°/12 cm | 3 154142 459107 |
| 981792 | 25-250 | Kit de 3 piezas - Regla 30 cm | 3 154149 817924 |
| 981710 | 24-144 | 24 Kit de 4 piezas - Regla 30 cm | 3 154149 817108 |



981792

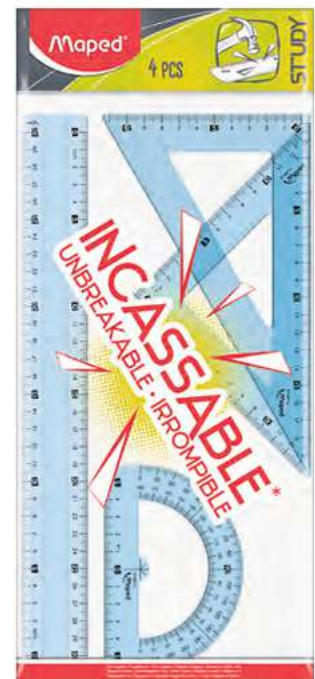

981710

Study Unbreakable Fancy - Reglas

- ¡Study Unbreakable se presenta esta vez en una versión más divertida con los animales Mini-Cute!
- **Material irrompible:** los productos pueden soportar flexiones y golpes en la mochila sin llegar a romperse
- 2 colores
- Doble graduación



245301



245401



245601

| ref | */** | | | |
|--------|--------|-------|----|-----------------|
| 245301 | 20-200 | | 10 | |
| | | 15 cm | 10 | 3 154142 453013 |
| 245401 | 20-200 | | 10 | |
| | | 20 cm | 10 | 3 154142 454010 |
| 245601 | 20-200 | | 10 | |
| | | 30 cm | 10 | 3 154142 456014 |

Irrompible

- ▶ **100% resistente a los golpes:** resistente a las flexiones, torsiones y golpes en la cartera; no se rompe gracias al material PET; material irrompible y duradero
- ▶ **Diseño técnico y académico:** para los ejercicios de geometría y para utilizarlo a diario gracias a su transparencia y su marcado preciso
- ▶ **Alta calidad de marcado:** impresión de las graduaciones con tinta UV para garantizar una mejor resistencia



Incassable - Reglas

- Realmente irrompible y duradero: material PET
- Borde antimanchas
- Empuñadura ergonómica
- Embalaje de cartón reciclable



| ref | */** | | | |
|--------|--------|------------------|----|-----------------|
| 244060 | 25-625 | | 15 | |
| | | 15 cm | 10 | 3 154142 440600 |
| | | Doble graduación | | |
| 258190 | 25-625 | | 15 | |
| | | 15 cm | 10 | 3 154142 581907 |
| | | Doble graduación | | |
| 244020 | 25-500 | | 15 | |
| | | 20 cm | 10 | 3 154142 440204 |
| 244030 | 30-240 | | 18 | |
| | | 30 cm | 12 | 3 154142 440303 |
| 244040 | 10-120 | | 40 | |
| | | 40 cm | | 3 154142 440402 |

244060

258190

244020

244030

244040



Incassable - Decímetros

- Realmente irrompible y duradero: material PET
- Empuñadura ergonómica
- Embalaje de cartón reciclable



244120



258890



244130



258990

| ref | */** | | | |
|--------|--------|--------------------------|--|-------------------|
| 244120 | 20-160 | 12 8 Doble decimetro | | 3 154 142 44 1201 |
| 258890 | 20-160 | 12 Doble decimetro | | 3 154 142 588906 |
| 244130 | 20-160 | 12 8 Triple decimetro | | 3 154 142 44 1300 |
| 258990 | 20-160 | 12 Triple decimetro | | 3 154 142 588903 |

Incassable - Escuadra 45°



- Realmente irrompible y duradero: material PET
- 0 situado en ángulo recto: para medir y trazar a la vez
- Empuñadura ergonómica
- Embalaje de cartón reciclable

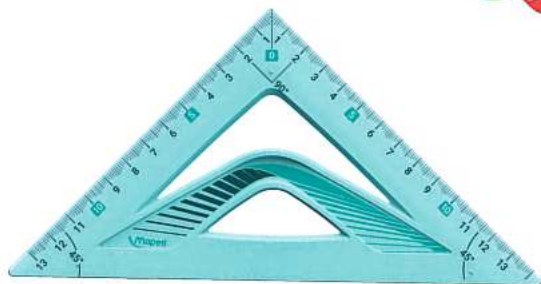

| ref | */** | | |
|--------|--------|--|------------------|
| 244421 | 25-300 | | Hipotenusa 21 cm |
| | | | 3 154 142 444219 |

Incassable - Escuadras 60°



- Realmente irrompible y duradero: material PET
- 0 situado en ángulo recto: para medir y trazar a la vez
- Empuñadura ergonómica
- Embalaje de cartón reciclable

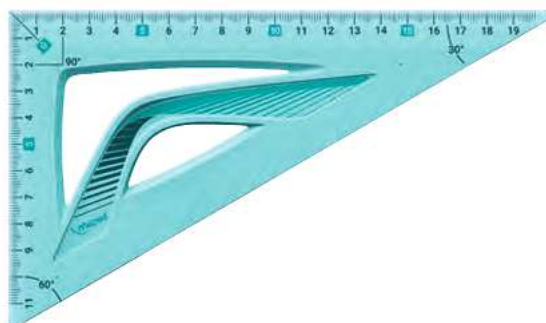

| ref | */** | | |
|--------|--------|--|------------------|
| 244621 | 25-300 | | Hipotenusa 21 cm |
| | | | 3 154 142 446213 |

Incassable - Escuadra 2 en 1



- Realmente irrompible y duradero: material PET
- 0 situado en ángulo recto: para medir y trazar a la vez
- Empuñadura ergonómica
- Embalaje de cartón reciclable

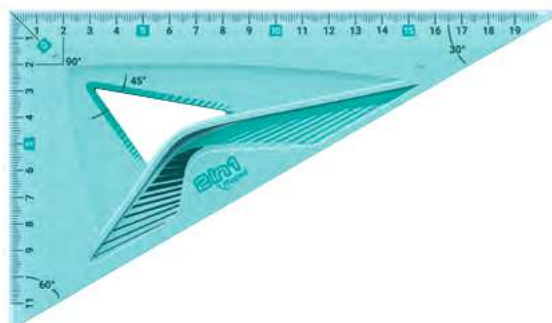

| ref | */** | | |
|--------|--------|--|------------------|
| 255110 | 25-300 | | Hipotenusa 21 cm |
| | | | 3 154 142 551108 |

Incassable - Transportadore 180°



- Realmente irrompible y duradero: material PET
- Indicación optimizada del centro
- Empuñadura ergonómica
- Señalización del sentido de lectura de las graduaciones
- Embalaje de cartón reciclable



| ref | */** | | |
|--------|--------|--|------------------|
| 244180 | 20-400 | | Base 12 cm |
| | | | 3 154 142 441805 |

Incassable - Mini kit 4 piezas

- Realmente irrompible y duradero: regla en material PET
- 1 regla de 15 cm
- 1 cartabón 60°/12 cm + 1 escuadra 45°/12 cm
- 1 transportador 180°/10 cm
- Embalaje de cartón reciclable

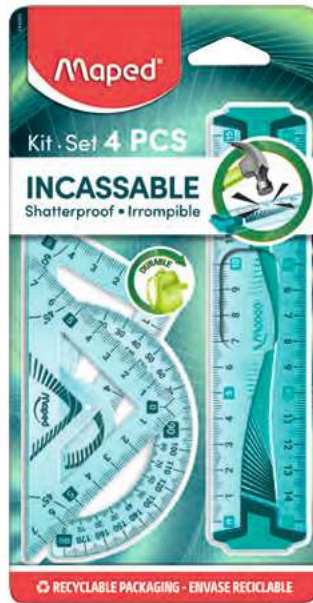

ref 244069 20-160 12 8 3 154 142 440693

Incassable - Maxi kit 4 piezas

- Realmente irrompible y duradero: material PET
- 1 regla de 30 cm
- 1 cartabón 60°/21 cm + 1 escuadra 45°/21 cm
- 1 transportador 180°/12 cm
- Embalaje de cartón reciclable



ref 244304 20-80 12 8 3 154 142 443045

Incassable - Kit 3 piezas 4 funciones

- Realmente irrompible y duradero: material PET
- 1 regla de 30 cm
- 1 escuadra 2 en 1 (60° y 45°)
- 1 transportador de 180°/12 cm
- Embalaje de cartón reciclable



ref 897120 20-80 12 8 3 154 148 971207

Aluminio

- ▶ **Alta calidad:** aluminio anodizado para una resistencia óptima
- ▶ **Seguridad:** protección de aristas
- ▶ **Envase:** blíster

Reglas

- Exclusivo, conteras «Protect System»: antiruido



| ref | */** | | |
|--------|--------|--|---|
| 120159 | 15-375 | 15 cm Sin «Protect System» Con zapata antideslizante |  |
| 120030 | 10-140 | 30 cm |  |
| 120040 | 8-80 | 40 cm |  |
| 120050 | 8-80 | 50 cm |  |

Decímetros

- Exclusivo, conteras «Protect System»: antiruido
- El cero centrado en 1 lado
- Empuñadura ergonómica



| ref | */** | | |
|--------|--------|------------------|---|
| 120120 | 15-120 | Doble decímetro |  |
| 120130 | 10-80 | Triple decímetro |  |

Escuadra 45°

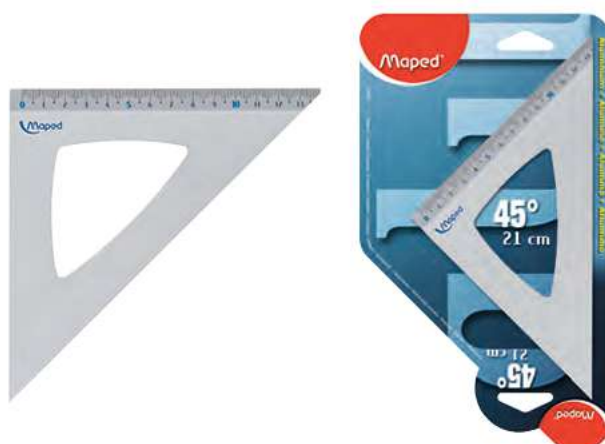

| ref | */** | | |
|--------|--------|------------------|---|
| 120421 | 10-180 | Hipotenusa 21 cm |  |

Cartabón 60°

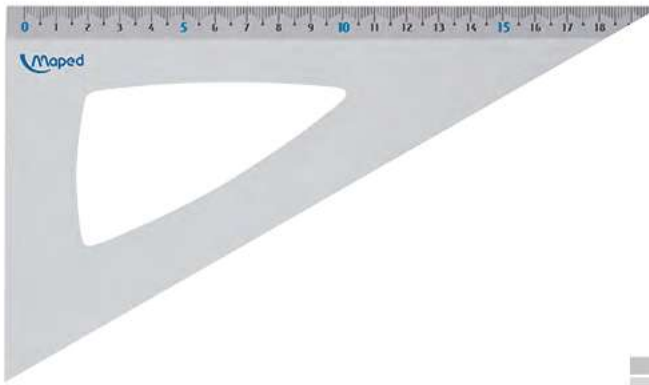

| ref | e/.. | | |
|--------|--------|------------------|--|
| 120621 | 15-300 | Hipotenusa 21 cm |  3 154 141 206214 |

Transportador 180°

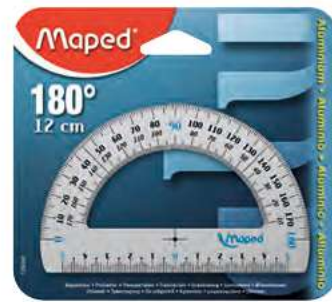

| ref | e/.. | | |
|--------|--------|------------|--|
| 129200 | 15-270 | Base 12 cm |  3 154 141 292002 |

ESCOLAR

Especiales y ingeniosos

► Herramientas para trazar, que aportan precisión y comodidad para necesidades específicas

Herramienta 2 en 1: regla + escuadra

- Regla + escuadra 2 en 1 de material irrompible
- Funciones: escuadra + trazado de paralelas + marcador de ángulos
- 20 cm + 0 situado en ángulo recto

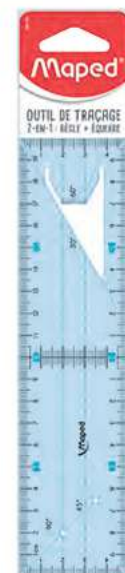

| ref | e/.. | | |
|--------|--------|---|--|
| 280110 | 25-500 |  |  3 154 142 801104 |

Regletas

- Graduaciones imborrables: grabados indelebles



| ref | */** | | |
|--------|--------|-------|---|
| 118200 | 10-500 | 20 cm |  |
| 118300 | 10-400 | 30 cm |  |
| 118500 | 10-100 | 50 cm |  |



118200



118300



118500

Escuadras Technic Geo

- Escuadra con anillo de sujeción
- 4 funciones: Escuadra graduada - Trazado simétrico - Trazado de paralelas - Transportador

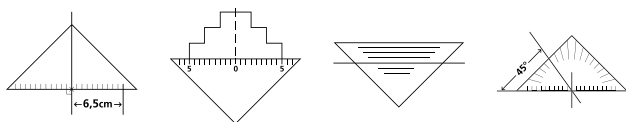

028700



277737



277747

| ref | */** | | |
|--------|--------|---------------------------------------|---|
| 028700 | 10-140 | Hipotenusa 26 cm Sujeción amovible |  |
| 277737 | 25-350 | Hipotenusa 16 cm |  |
| 277747 | 50-400 | Hipotenusa 16 cm |  |

Escuadra Geo-Flex

- Escuadra de plástico muy flexible e irrompible
- Envases: bolsa protectora para colgar
- 4 funciones: Escuadra graduada - Trazado simétrico - Trazado de paralelas - Transportador

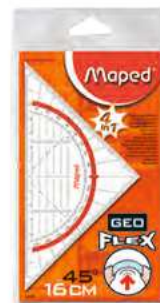
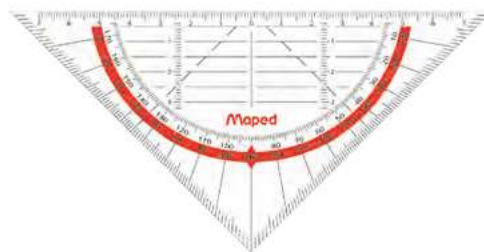
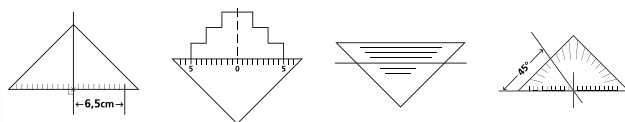

| ref | */** | | |
|--------|--------|------------------|---|
| 028600 | 20-400 | Hipotenusa 16 cm |  |

Trazador de círculos

- **Anti-golpes:** producto realizado en material plástico resistente a los golpes
- **Envase:** bolsa de protección colgable
- Círculos de \varnothing 1 a \varnothing 35 mm

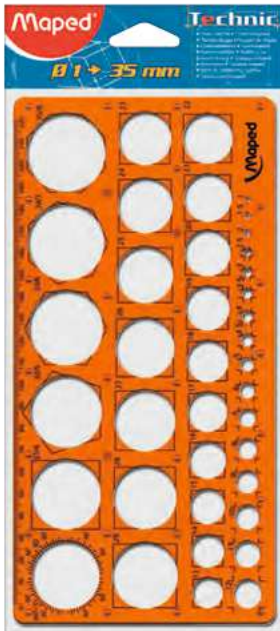

| ref | */** | 3 154 142 776204 |
|--------|--------|------------------|
| 277620 | 20-280 | |

Normographe

- **Anti-golpes:** producto realizado en material plástico resistente a los golpes
- **Ideal para un uso académico:** elaboración de mapas y esquemas
- **Envase:** blister colgable

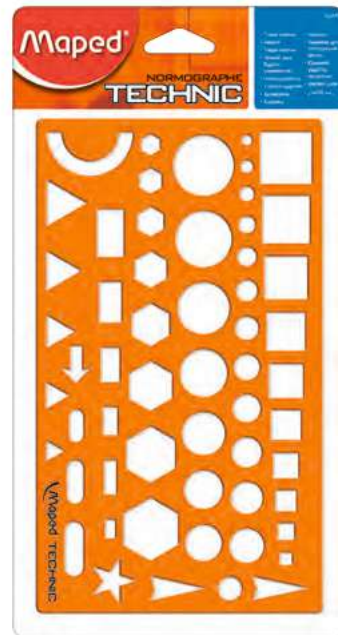

| ref | */** | 3 154 149 224104 |
|--------|--------|------------------|
| 922410 | 20-160 | |

Plantilla de letras 30 cm

- **Anti-golpes:** producto realizado en material plástico resistente a los golpes
- **Envase:** bolsa protectora para colgar
- Puede utilizarse con todo tipo de bolígrafos



| ref | */** | 3 154 142 586087 |
|--------|--------|------------------|
| 258608 | 20-200 | |

Mapa de Francia

- **Anti-golpes:** producto realizado en material plástico resistente a los golpes
- **Embalaje:** bolsa de protección colgable
- **Altura:** 18 cm
- Francia administrativa, Córcega, Dom-Tom, relieves y ríos, recorte regional 2016





| ref | */** | 3 154 142 554000 |
|--------|--------|------------------|
| 255400 | 15-180 | |

Escalas de reducción

- Estuche reutilizable e irrompible



| ref | */** | |
|--------|-------|---|
| 240011 | 5-135 |  |
| 240014 | 5-135 |  |
| 240013 | 5-135 |  |
| 240115 | 5-135 |  |



240011 240014 240013 240115

| | 1:20 | 1:25 | 1:33,33 | 1:50 | 1:75 | 1:100 | 1:125 | 1:200 | 1:250 | 1:300 | 1:400 | 1:500 | 1:1000 | 1:1250 | 1:1500 | 1:2000 | 1:2500 |
|----------|------|------|---------|------|------|-------|-------|-------|-------|-------|-------|-------|--------|--------|--------|--------|--------|
| 240011 6 | ■ | ■ | | ■ | ■ | ■ | ■ | | | | | | | | | | |
| 240014 7 | | | | | | ■ | | ■ | ■ | ■ | ■ | ■ | | | | | |
| 240013 0 | ■ | ■ | ■ | ■ | ■ | ■ | ■ | | | | | | | | | | |
| 240115 1 | | | | | | | | | | | | | ■ | ■ | ■ | ■ | ■ |

Aprendizaje

- Una gama completa de compases de aprendizaje fiable y con diseños de colores, responde a todas las problemáticas de seguridad y ergonomía diagnosticadas por los equipos de investigación de Maped



Pulse - Mina

- Punta de seguridad
- Producto compuesto en un 70% de material reciclado
- Embalaje de cartón reciclable



018100

518100

| ref | */** | | | |
|--------|--------|------|------|---|
| 018100 | 25-250 | ■ 15 | ■ 10 |  |
| 518100 | 30-480 | ■ 18 | ■ 12 |  |

Pulse con abrazadera

- Punta de seguridad
- Producto compuesto en un 70% de material reciclado
- Embalaje de cartón reciclable

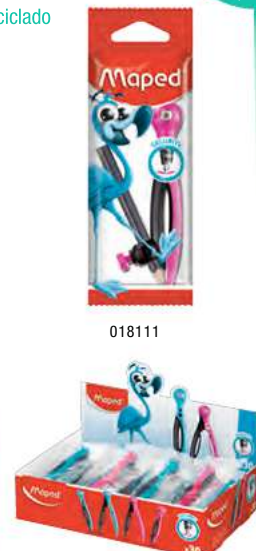

018111

518110

| ref | */** | | | |
|--------|--------|------|-----|---|
| 018111 | 20-200 | ■ 12 | ■ 8 |  |
| 518110 | 20-320 | ■ 12 | ■ 8 |  |

Graphic 360 con abrazadera

- Durabilidad: brazos de plástico reforzado con fibra de vidrio



| ref | */** | | | | |
|-------------------|--------|--|---|---|---|
| 019110 | 12-144 | | 5 | 4 | 3 |
| 3 154 140 19 1108 | | | | | |

Graphic 360 Intercambiable Caja 3 Piezas

- Durabilidad: brazos de plástico reforzado con fibra de vidrio
- 1 compás intercambiable (doble función abrazadera y mina)
- Caja de almacenaje



| ref | */** | | | | |
|---|--------|--|---|---|---|
| 519143 | 10-100 | | 4 | 3 | 3 |
| 1 compás + 1 estuche de minas + 1 afila minas 3 154 145 19 1431 | | | | | |

Kid'Z - Mina

- Con brazos ergonómicos concebidos para el aprendizaje
- Zona de empuñadura ergonómica
- Punta de seguridad + 1 mina de recambio incluida
- El 1% del volumen de negocios dedicada a financiar iniciativas en favor del acceso y el apoyo a la educación



19150



19151

| ref | */** | | | | |
|-------------------|--------|--|----|---|---|
| 19150 | 12-144 | | 6 | 3 | 3 |
| 3 154 141 9 15109 | | | | | |
| 19151 | 24-192 | | 12 | 6 | 6 |
| 3 154 141 9 15116 | | | | | |

Kid'Z con abrazadera

- Con brazos ergonómicos concebidos para el aprendizaje
- Zona de empuñadura ergonómica
- Punta de seguridad
- El 1% del volumen de negocios dedicada a financiar iniciativas en favor del acceso y el apoyo a la educación



191690



191610



191611

| ref | */** | | | | |
|-------------------|--------|--|----|---|---|
| 191610 | 12-144 | | 6 | 3 | 3 |
| 3 154 141 9 16106 | | | | | |
| 191690 | 12-144 | | | | |
| 3 154 141 9 16908 | | | | | |
| 191611 | 24-192 | | 12 | 6 | 6 |
| 3 154 141 9 16113 | | | | | |



Kid'Z 360° Agility – Mina

- El compás que gira por ti
- Agility system : trazos fáciles y rápidos, en un solo movimiento



181510



181511

Kid'Z 360° Agility con abrazadera

- El compás que gira por ti
- Agility system : trazos fáciles y rápidos, en un solo movimiento



181610



181611

| ref | */** | | |
|-----------------|--------|--|------|
| 181510 | 12-144 | | 8 4 |
| 3 154141 815102 | | | |
| 181511 | 24-192 | | 15 9 |
| 3 154141 815119 | | | |

| ref | */** | | |
|-----------------|--------|--|------|
| 181610 | 12-144 | | 8 4 |
| 3 154141 816109 | | | |
| 181611 | 24-192 | | 15 9 |
| 3 154141 816116 | | | |

Stop & Safe con abrazadera

- Sistema de seguridad avanzado: punta seca auto-retráctil
- Rueda de ajuste y bloqueo de los brazos
- Empuñadura ergonómica bi-material
- Incluidos: folleto para aprender a dibujar rosetones
- Hasta finales de stocks



ref 192610 20-160 10 5 5
1 compás con abrazadera + 1 lápiz + 1 leaflet 3 154 141 926105

Stop & Safe - Caja con abrazadera

- Sistema de seguridad avanzado: punta seca auto-retráctil
- Rueda de ajuste y bloqueo de los brazos
- Empuñadura ergonómica bi-material



ref 192611 10-120 4 3 3
1 compás con abrazadera + 1 lápiz mini Black'Peps 3 154 141 926112

Stop & Safe - Mina - Caja 3 Piezas

- Sistema de seguridad avanzado: punta seca auto-retráctil
- Rueda de ajuste y bloqueo de los brazos
- Empuñadura ergonómica bi-material



ref 192511 10-120 4 3 3
1 compás mina + 1 estuche de minas + 1 afila minas 3 154 141 925115

Escolares

- ▶ Stop System y Study, dos logros que ilustran la fuerza innovadora de Maped al servicio de una gama completa de compases escolares.
- ▶ Una oferta, respectivamente tradicional y moderna, que combina la innovación y el conocimiento técnico más revolucionarios

10+

Start - Mina

- Brazos de metal para mejorar la rigidez





| ref | */** | | |
|--------|--------|---|---|
| 197510 | 20-160 |  |  |

Start - Caja 3 Piezas

- Brazos de metal para mejorar la rigidez
- Ingenioso: accesorios intercambiables





| ref | */** | | |
|--------|--------|--|--|
| 197512 | 20-180 |  |  1 compás mina + 1 abrazadera universal + 1 estuche de minas |

Start - Caja 5 Piezas

- Brazos de metal para mejorar la rigidez
- Ingenioso: accesorios intercambiables





| ref | */** | | |
|--------|--------|---|---|
| 197513 | 20-180 |  |  1 compás mina + 1 abrazadera universal + 1 portaminas de 0.5 mm + 1 afila minas + 1 estuche de minas |

Start - Caja 8 Piezas

- Brazos de metal para mejorar la rigidez
- Ingenioso: accesorios intercambiables



| ref | */** | | |
|--------|-------|--|---|
| 197514 | 10-70 |  |  1 compás mina + 1 mini compás bigotera + 1 con abrazadera universal + 1 portaminas de 0.5 mm + 1 goma + 1 afila minas + 1 estuche de minas + 1 estuche de minas 0.5 mm |

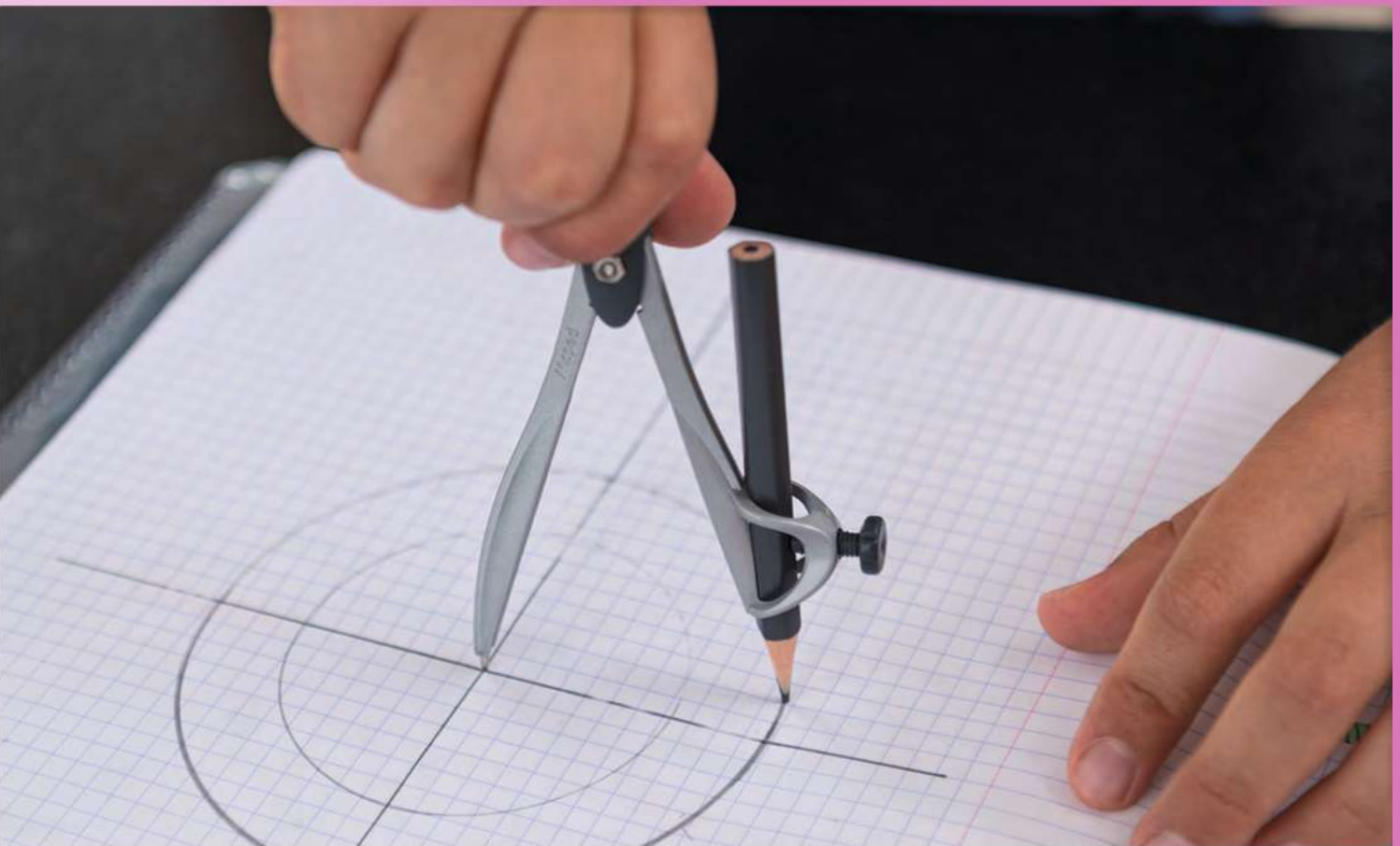

Study - Mina

- Brazos de metal
- Tapa ergonómica
- Caja con regla integrada



119450



199590



199511

Study con abrazadera

- Brazos de metal
- Tapa ergonómica
- Caja con regla integrada



119410



199190



199111

| ref | */** | | |
|--------|--------|--|----------------------|
| 119450 | 20-240 | 1 compás mina + 1 estuche de minas El 1% del volumen de negocios dedicada a financiar iniciativas en favor del acceso y el apoyo a la educación | 3 154 141 194504 |
| 199590 | 20-240 | 1 compás + 1 estuche de minas | 3 154 141 995903 |
| 199511 | 30-480 | | 3 154 141 995118 |

| ref | */** | | |
|--------|--------|---|----------------------|
| 119410 | 20-240 | 1 compás con abrazadera + 1 lápiz El 1% del volumen de negocios dedicada a financiar iniciativas en favor del acceso y el apoyo a la educación | 3 154 141 194108 |
| 199190 | 20-240 | 1 compás con abrazadera + 1 lápiz | 3 154 141 991905 |
| 199111 | 20-320 | | 3 154 141 991110 |

Study - Portaminas 0.5 mm

- Brazos de metal
- Tapa ergonómica
- Caja con regla integrada



ref 119430 20-240
 4 12 4
 1 compás portaminas
 + 1 estuche de minas 0.5 mm



Study - Caja 5 Piezas

- Brazos de metal
- Tapa ergonómica
- Caja con regla integrada



ref 119405 20-240
 4 12 4
 1 compás mina + 1 estuche de minas
 + 1 afila minas + 1 destornillador + 1 goma



Study Stop - Mina

- Sistema exclusivo de bloqueo de los brazos: precisión garantizada
- Brazos de metal
- Tapa ergonómica
- Caja con regla integrada



ref 195110 20-240
 10 6 4
 1 compás + 1 estuche de minas



Study Stop con abrazadera

- Sistema exclusivo de bloqueo de los brazos: precisión garantizada
- Brazos de metal
- Tapa ergonómica
- Caja con regla integrada



ref 195210 20-240
 10 6 4
 1 compás con abrazadera + 1 lápiz



Study Pastel - Mina



- Brazos de metal
- Tapa ergonómica Pastel
- Caja de color pastel con regla integrada







Study Pastel con abrazadera

- Brazos de metal
- Tapa ergonómica Pastel
- Caja de color pastel con regla integrada



| ref | e/.. | | | | |
|--|--------|---|---|---|---|
| 194510 | 20-240 |  |  |  | 5 |
| 1 compás + 1 estuche de minas | | | | | |
|  3 154141 945106 | | | | | |

| ref | e/.. | | | | |
|--|--------|---|--|---|---|
| 194111 | 20-240 |  |  |  | 5 |
| 1 compás con abrazadera + 1 lápiz | | | | | |
|  3 154141 941115 | | | | | |

Study Pop - Mina

- Brazos de metal coloridos
- Empuñadura ergonómica colorida
- Caja de color con regla integrada



Study Pop - Con abrazadera

- Brazos de metal coloridos con abrazadera para lápiz
- Empuñadura ergonómica colorida
- Caja de color con regla integrada



| ref | e/.. | | | | |
|-----------------|--------|---|---|---|----|
| 194500 | 20-240 |  |  |  | 10 |
| 3 154141 945007 | | | | | |

| ref | e/.. | | | | |
|-----------------|--------|---|--|---|----|
| 194102 | 20-240 |  |  |  | 10 |
| 3 154141 941023 | | | | | |

Metal Open - Mina

- Seguridad: protector de punta seca y mina
- Empuñadura ergonómica
- Ingenioso: accesorios intercambiables



| ref | */** | | | | |
|--------|--------|---|---|---|------------------|
| 369000 | 20-160 | | | | |
| | | 8 | 6 | 6 | 3 154 143 690004 |

Metal Open con abrazadera

- Seguridad: protector de punta seca y mina
- Empuñadura ergonómica
- Ingenioso: accesorios intercambiables



| ref | */** | | | | |
|--------|--------|---|---|---|------------------|
| 036910 | 20-160 | | | | |
| | | 8 | 6 | 6 | 3 154 140 369101 |
| | | 1 compás con abrazadera + 1 lápiz mini Black'Peps | | | |

Metal Open - Caja 3 Piezas

- Seguridad: protector de punta seca y mina
- Empuñadura ergonómica
- Ingenioso: accesorios intercambiables



| ref | */** | | | | |
|--------|--------|---|---|---|------------------|
| 536953 | 10-120 | | | | |
| | | 4 | 3 | 3 | 3 154 145 369533 |
| | | 1 compás mina + 1 abrazadera universal + 1 estuche de minas | | | |

Metal Open - Caja 5 Piezas

- Seguridad: protector de punta seca y mina
- Empuñadura ergonómica
- Ingenioso: accesorios intercambiables



| ref | •/•• | | |
|--------|--------|-----------|------------------------|
| 536955 | 10-120 | 4 3 3 | 3 154 14 5136955 7 |

1 compás mina+ 1 con abrazadera universal +
1 lápiz mini Black'Peps + 1 afila minas
+ 1 estuche de minas

Stop System - Mina

- Innovación exclusiva de Maped
- Concepto Stop System con patente: bloqueo de los brazos
- Seguridad: protector de punta seca y mina

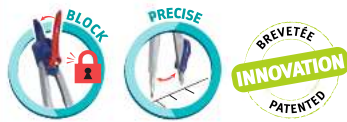

| ref | •/•• | | |
|--------|--------|--|------------------------|
| 019600 | 20-160 | | 3 154 14 0119600 4 |

Stop System - Caja con abrazadera

- Innovación exclusiva de Maped
- Concepto Stop System con patente: bloqueo de los brazos
- Seguridad: protector de punta seca y mina



| ref | •/•• | | |
|--------|--------|--|------------------------|
| 196510 | 10-120 | | 3 154 14 1196510 4 |

1 compás con abrazadera
+ 1 lápiz mini Black'Peps

Stop System - Caja 3 Piezas

- Innovación exclusiva de Maped
- Concepto Stop System con patente: bloqueo de los brazos
- Seguridad: protector de punta seca y mina



| ref | */** | | |
|--------|--------|--|--------------------|
| 196100 | 10-120 | | |
| | | 1 compás mina + 1 abrazadera universal + 1 estuche de minas | 3 154 14 1 96 1007 |

Stop System - Caja 5 Piezas

- Innovación exclusiva de Maped
- Concepto Stop System con patente: bloqueo de los brazos
- Seguridad: protector de punta seca y mina



| ref | */** | | |
|--------|--------|--|--------------------|
| 196101 | 10-120 | | |
| | | 1 compás mina + 1 abrazadera universal + 1 portaminas de 0.5 mm + 1 estuche de minas + 1 afila minas | 3 154 14 1 96 1014 |

Stop System - Caja 7 Piezas

- Innovación exclusiva de Maped
- Concepto Stop System con patente: bloqueo de los brazos
- Seguridad: protector de punta seca y mina



| ref | */** | | |
|--------|-------|---|--------------------|
| 196102 | 10-80 | | |
| | | 1 compás mina Stop System + 1 lápiz mini Black'Peps + 1 con abrazadera universal + 1 portaminas de 0.5mm + 1 afila minas + 1 estuche de minas + 1 goma | 3 154 14 1 96 1021 |

Stop System Easy - Mina

- Innovación exclusiva de Maped
- Concepto Stop System con patente: bloqueo de los brazos INTUITIVO
- Seguridad: protector de punta seca y mina



| ref | */** | | |
|--------|--------|--|--------------------|
| 196210 | 20-160 | | |
| | | | 3 154 14 1 96 2103 |

Stop System Easy con abrazadera

- Innovación exclusiva de Maped
- Concepto Stop System con patente: bloqueo de los brazos INTUITIVO
- Seguridad: protector de punta seca y mina



Stop System Easy - Caja 3 Piezas

- Innovación exclusiva de Maped
- Concepto Stop System con patente: bloqueo de los brazos INTUITIVO
- Seguridad: protector de punta seca y mina



| | | | |
|--|--------|--|--|
| ref | */** | | |
| 196610 | 10-120 | | |
| 1 con abrazadera universal + 1 mini Black'peps 3 154141 966101 | | | |

| | | | |
|---|--------|--|--|
| ref | */** | | |
| 196310 | 10-120 | | |
| 1 compás mina + 1 abrazadera + 1 estuche de minas 3 154141 963100 | | | |

Origin - Mina

- Hecho en Francia
- Durabilidad : brazos de acero
- Compas garantizada por 3 años



Origin con abrazadera

- Hecho en Francia
- Durabilidad : brazos de acero
- Compas garantizada por 3 años



| | | | |
|-----------------------|--------|--|--|
| ref | */** | | |
| 024009 | 20-200 | | |
| 10 10 3 154140 240097 | | | |

| | | | |
|-----------------------|--------|--|--|
| ref | */** | | |
| 314600 | 20-200 | | |
| 10 10 3 154143 146006 | | | |

Origin - Caja con abrazadera

- Hecho en Francia
- Durabilidad : brazos de acero
- Compas garantizada por 3 años



| ref | */** | | | |
|---|--------|---|---|-----------------|
| 121651 | 10-100 | 5 | 5 | 3 154141 216510 |
| 1 compás con abrazadera Protect + 1 lápiz mini Black'Peps | | | | |

Origin - Caja 3 Piezas

- Hecho en Francia
- Durabilidad : brazos de acero
- Compas garantizada por 3 años



| ref | */** | | | |
|---|--------|---|---|-----------------|
| 305811 | 10-100 | 5 | 5 | 3 154143 058118 |
| 1 compás mina + 1 con abrazadera universal + 1 estuche de minas | | | | |

Origin - Caja 5 Piezas

- Hecho en Francia
- Durabilidad : brazos de acero
- Compas garantizada por 3 años



| ref | */** | | | |
|---|--------|---|---|-----------------|
| 305812 | 10-100 | 5 | 5 | 3 154143 058125 |
| 1 compás mina + 1 con abrazadera universal + 1 mini Black'Peps + 1 afila minas + 1 estuche de minas | | | | |

Técnicas

► Una gama diseñada para responder a las expectativas más altas en cuanto a precisión y fiabilidad. Es ideal tanto para los estudiantes como para los profesionales que busquen un compás de calidad y resistente.

N°308 Compás Técnico

- Brazo articulado : estabilidad y precisión del trazo
- Caja de almacenaje
- Diámetro máximo : 30 cm



N°415 Compás técnico Set de dibujo de precisión

- Brazo articulado : estabilidad y precisión del trazo
- Tornillo micrométrico : ajuste preciso de la medida
- Caja de almacenaje
- Diámetro máximo : 52 cm con la extensión



| ref | */** | | |
|--------|--------|--|---|
| 178001 | 25-100 | Compás técnico clásico 130 mm + Funda mina de repuesto 2 mm + Adaptador para bolígrafo / lápiz + Tuerca de recambio |  |

| ref | */** | | |
|--------|-------|--|---|
| 178002 | 15-60 | Compás técnico clásico 130 mm + Compás de bigoterías de precisión 105 mm + Alargador externo 140 mm + Funda mina de repuesto 2 mm + Adaptador para bolígrafo / lápiz + Tuerca de recambio |  |

N°421 Compás Técnico de ajuste rápido

- Ajuste rápido: ideal para fijar las medidas del radio
- Tornillo micrométrico : ajuste preciso de la medida
- Brazo articulado: estabilidad y precisión del trazo
- Caja de almacenaje
- Diámetro máximo : 30 cm



N°421 Compás técnico bigotero con alargadera

- Ajuste rápido: ideal para fijar las medidas del radio
- Tornillo micrométrico: ajuste de la medida preciso
- Brazo articulado: estabilidad y precisión del trazado
- Caja de almacenaje
- Diámetro máximo: 30 cm



| ref | */** | | |
|--------|-------|--|---|
| 178101 | 15-60 | Compás técnico de ajuste rápido y micrométrico 160 mm + Funda mina de repuesto 2 mm + Adaptador para bolígrafo / lápiz + Tuerca de recambio |  |

| ref | */** | | |
|--------|-------|---|---|
| 178102 | 15-60 | Bigotero de ajuste rápido y micrométrico 160 mm Estuche de 5 piezas: + Funda mina de repuesto de 2 mm + Adaptador para bolígrafo + Tuerca de recambio + Alargador externo 140 mm |  |

Technic Compact - Mina

- **Concepto Stop System con patente:** bloqueo de los brazos
- **Brazos articulables:** se pliega para mayor seguridad y comodidad en el estuche
- **Características:** Ø máx. 360 mm, anchura del compás 150 mm



| ref | */** | | |
|--------|--------|----------------------------|--|
| 038700 | 20-160 | Incluye 1 estuche de minas |  3 154 140 387006 |

Technic Compact - Caja 4 Piezas

- **Concepto Stop System con patente:** bloqueo de los brazos
- **Brazos articulables:** se pliega para mayor seguridad y comodidad
- **Características:** Ø máx. 360 mm, longitud del compás 150 mm



| ref | */** | | |
|--------|--------|---|--|
| 538700 | 10-120 | 1 compás mina + 1 abrazadera Universal + 1 afila minas + 1 estuche de minas |  3 154 145 387001 |

Technic Compact - Caja 5 Piezas

- **Concepto Stop System con patente:** bloqueo de los brazos
- **Brazos articulables:** se pliega para mayor seguridad y comodidad
- **Características:** Ø máx. 360 mm, longitud del compás 150 mm



| ref | */** | | |
|--------|--------|--|--|
| 538705 | 10-120 | 1 compás mina + 1 abrazadera universal + 1 portaminas de 0.5 mm + 1 afila minas + 1 estuche de minas |  3 154 145 387056 |

Technic Compact - Caja 7 Piezas

- Concepto Stop System con patente: bloqueo de los brazos
- Brazos articulables: se pliega para mayor seguridad y comodidad
- Características: Ø máx. 360 mm, longitud del compás 150 mm



| ref | e/** | | |
|--------|-------|--|---|
| 538717 | 10-80 | 1 compás mina + 1 alargadera + 1 con abrazadera universal + 1 lápiz mini Black'Peps + 1 portaminas de 0.5mm + 1 afila minas + 1 estuche de minas |  |

ESCOLAR

Accesorios de compases

- Portaminas y mini lápices de grafito especialmente concebidos para adaptarse a todos los compases: accesorios que simplifican el trabajo y durante mucho tiempo

Mini Black'Peps

- Práctico: formato mini adaptado a compases con abrazadera
- Ganancia de espacio en el estuche



10 Minas - Ø 2 mm



| ref | e/** | | |
|--------|--------|------------|---|
| 850211 | 24-432 | x3 Mini HB |  |

| ref | e/** | | |
|--------|--------|--|---|
| 134210 | 30-720 | |  |

Bigoterías

► La pericia histórica de Maped se extiende a una amplia oferta de compases técnicos, fieles a la tradición desde el punto de vista de unos, modernos e novedosos desde el punto de vista de otros

Precision System - Caja 3 Piezas

- Características: Ø máx. 300 mm, longitud del compás 165 mm
- Caja de almacenaje



291010



291091

| ref | */** | | |
|--------|-------|---|----------------------|
| 291010 | 10-80 | 4 3 3 | 3 154 142 9 10 10 3 |
| | | 1 bigotera + 1 abrazadera universal + 1 estuche de minas | |
| 291091 | 10-70 | 1 | 3 154 142 9 10 9 1 2 |
| | | 1 bigotera Precision System + 1 con Abrazadera universal + 1 estuche de minas | |

Precision System Fancy - Caja 3 Piezas

- Brazos de metal decorados
- Características: Ø máx. 300 mm, longitud del compás 165 mm
- Caja de color



| ref | */** | | |
|--------|-------|---|---------------------|
| 291013 | 10-80 | 5 5 | 3 154 142 9 10 13 4 |
| | | 1 bigotera + 1 abrazadera + 1 estuche de minas | |

Premium - Caja 4 Piezas

- Apertura rápida: tornillo de triple rosca
- Alta precisión: brazo articulado
- Características: Ø máx. 300 mm, longitud del compás 165 mm
- Hasta finales de stocks



| ref | */** | | |
|--------|-------|---|---------------------|
| 290310 | 10-80 | | 3 154 142 9 03 10 5 |
| | | 1 bigotera Premium + 1 con Abrazadera universal (compatible con tubular) + 1 estuche de minas + 1 portaminas de 0.5mm | |

Math sets

► **Compases, sacapuntas, gomas, trazado:** la experiencia Maped aplicada a los Math Sets, varios "packs" adaptados a todos los niveles de aprendizaje

Pulse - Kit de 8 Piezas

• Estuche reutilizable



| ref | •/•• | | |
|--|-------|-----|------------------|
| 018119 | 12-84 | 7 5 | 3 154 140 181192 |
| 1 compás con abrazadera + 1 sacapuntas Vivo + 1 goma + 1 lápiz + 1 regla + 1 escuadra y 1 cartabón + 1 transportador | | | |

Essentials - Kit de 9 Piezas



| ref | •/•• | | |
|--|--------|---|------------------|
| 194609 | 12-144 | 1 | 3 154 141 946097 |
| 1 compás con abrazadera + 1 compás de doble punta seca + 1 sacapuntas + 1 goma + 1 lápiz + 1 regla + 1 escuadra y 1 cartabón + 1 transportador | | | |

Kid'Z - Kit de 8 Piezas



| ref | •/•• | | |
|---|-------|-----|------------------|
| 519118 | 10-80 | 6 4 | 3 154 145 191189 |
| 1 compás con abrazadera + 1 sacapuntas Boogy sin compartimento de recogida + 1 goma + 1 lápiz + 1 regla + 1 escuadra y 1 cartabón + 1 transportador | | | |

Kid'Z - Kit de 9 Piezas

• Hasta finales de stocks



| ref | •/•• | | |
|---|-------|-----|------------------|
| 519119 | 10-80 | 6 4 | 3 154 145 191196 |
| 1 compás con abrazadera + 1 compás mina + 1 sacapuntas Boogy sin compartimento de recogida + 1 goma + 1 lápiz + 1 regla + 1 escuadra y 1 cartabón + 1 transportador | | | |

Stop & Safe - Kit de 8 Piezas

- Hasta finales de stocks



| ref | */** | | |
|---|-------|------|--|
| 192608 | 10-80 | 5 5 | |
| 1 compás con abrazadera + 1 sacapuntas Boogy sin compartimento de recogida + 1 goma + 1 lápiz mini Black'Peps + 1 regla + 1 escuadra y 1 cartabón + 1 transportador | | | |

Study Stop - Kit de 8 Piezas

- Caja metálica
- Hasta finales de stocks



| ref | */** | | |
|---|-------|--|--|
| 195208 | 10-60 | | |
| 1 compás con abrazadera + 1 sacapuntas + 1 goma + 1 lápiz + 1 regla + 1 escuadra y 1 cartabón + 1 transportador | | | |

Study - Kit de 8 Piezas

- Caja metálica



| ref | */** | | |
|---|-------|--|--|
| 119418 | 12-60 | | |
| 1 compás con abrazadera + 1 sacapuntas + 1 goma + 1 lápiz + 1 regla + 1 escuadra y 1 cartabón + 1 transportador | | | |

Study - Kit de 10 Piezas

- Caja metálica



019409



119409



| ref | */** | | |
|---|------|--|--|
| 019409 | 60- | | |
| 1 compás con abrazadera + 1 compás + 1 sacapuntas + 1 goma + 1 lápiz + 1 regla + 1 escuadra y 1 cartabón + 1 transportador + 1 estuche de minas | | | |

| ref | */** | | |
|--|------|--|--|
| 119409 | 72- | | |
| 1 compás con abrazadera + 1 compás + 1 sacapuntas + 1 goma + 1 lápiz + 1 regla + 1 escuadra y 1 cartabón + 1 transportador + 1 estuche de minas Hasta finales de stocks | | | |

Mathset Study Pop



- Caja de almacenaje de metal colorida
- Brazos de metal decorados



| ref | •/•• | | |
|--------|-------|---|--|
| 199113 | 12-72 |  1 compás Fancy con abrazadera + 1 compás Fancy con mina + 1 sacapuntas + 1 goma + 1 lápiz + 1 regla + 2 escuadras + 1 transportador + 1 caja de metal colorida |  3 154 141 99 1134 |

Metal Open - Kit de 9 Piezas





| ref | •/•• | | |
|--------|-------|--|--|
| 536919 | 10-80 |  1 compás con abrazadera + 1 compás mina + 1 sacapuntas + 1 goma + 1 lápiz mini Black'Peps + 1 regla + 1 escuadra y 1 cartabón + 1 transportador |  3 154 145 36 9199 |

Stop System Innovation - Kit de 8 Piezas

- Hasta finales de stocks



| ref | •/•• | | |
|--------|-------|--|--|
| 196608 | 10-80 |  1 compás con abrazadera + 1 sacapuntas + 1 goma + 1 lápiz mini Black'Peps + 1 regla + 1 escuadra y 1 cartabón + 1 transportador |  3 154 141 96 6088 |

Aprendizaje

- ▶ Nuestras tijeras de aprendizaje están diseñadas para garantizar la seguridad (puntas redondas) y la comodidad de corte a los niños
- ▶ Trabajamos la ergonomía de los aros para mejorar el empuñadura de las tijeras y ayudar a los niños a aprender a recortar

KidiPulse

- Ideales para aprender a recortar
- Seguridad: cuchillas no conductoras de la electricidad y que no cortan ni la piel, ni los cabellos, ni la ropa



| ref | */** | | |
|--------|--------|--|--|
| 472110 | 12-144 | | |
| 472112 | 20-240 | | |



472110



472112

KidiCut 12 cm

- Iniciación: a partir de 2 años
- Seguridad: lamas de fibra de vidrio que no conductoras de la electricidad y que no cortan ni la piel, ni el pelo, ni la ropa
- Universo lúdico y afectivo



| ref | */** | | |
|--------|--------|--|--|
| 037800 | 12-144 | | |
| 137702 | 20-240 | | |



037800



137702

KidiCraft

- Ideales para aprender a recortar divirtiéndose
- 3 formas de corte : recto, onda y zigzag
- 3 divertidos diseños: cocodrilo, elefante y tiburón
- Seguridad: cuchillas no conductoras de la electricidad y que no cortan ni la piel, ni los cabellos, ni la ropa



| ref | */** | | |
|--------|-------|----|--|
| 981727 | 12-72 | | |
| | | x3 | |



Vivo Smiling Planet 12 cm



- Aros ergonómicos 3D fabricados con un 50% de fibra de madera con certificación FSC Mix, de bosques gestionados de forma responsable
- Seguridad: cuchillas redondeadas
- Embalaje de cartón reciclable



NEW!



472020FM



472021FM

Vivo Smiling Planet 12 cm Zurdos



- Aros ergonómicos 3D fabricados con un 50% de fibra de madera con certificación FSC Mix, de bosques gestionados de forma responsable
- Auténticas tijeras para zurdos: cuchillas invertidas
- Seguridad: cuchillas redondeadas
- Embalaje de cartón reciclable



NEW!



472520FM



472521FM

| ref | */** | | |
|----------|--------|--|--|
| 472020FM | 12-144 | | |
| 472021FM | 20-300 | | |

| ref | */** | | |
|----------|--------|--|--|
| 472520FM | 12-144 | | |
| 472521FM | 20-240 | | |

Koopy 13 cm

- Apertura automática para facilitar el corte
- Universo lúdico y afectivo



037910



137910

| ref | */** | | |
|--------|--------|--|--|
| 037910 | 12-144 | | |
| 137910 | 20-120 | | |

Escolares

- ▶ Además de controlar el proceso de la fabricación, Maped se apoya en el conocimiento de un gabinete de ergonomos para mejorar continuamente la comodidad de sus aros
- ▶ Nuestros productos son testados permanentemente para lograr cada vez mayor calidad y una durabilidad óptima de nuestras cuchillas

Essentials Pulse 13 cm

- **Uso escolar:** tijeras ergonómicas
- **Seguridad:** cuchillas redondeadas
- **Hojas graduadas en cm**



464290



464210



464212

| ref | */** | | | | | | | | |
|--------|--------|--|----|--|---|--|---|--|-----------------|
| 464210 | 24-480 | | 10 | | 6 | | 8 | | 3 154144 642101 |
| 464290 | 24-480 | | | | | | | | 3 154144 642903 |
| 464212 | 24-360 | | 10 | | 6 | | 8 | | 3 154144 642125 |

Essentials Pulse 13 cm - Zurdos

- **Uso escolar:** tijeras ergonómicas
- **Seguridad:** cuchillas redondeadas
- **Hojas graduadas en cm**
- **Auténticas tijeras para zurdos:** cuchillas invertidas



464310



464312

| ref | */** | | | | | | | | |
|--------|--------|--|---|--|---|--|---|--|-----------------|
| 464310 | 12-144 | | 5 | | 3 | | 4 | | 3 154144 643108 |
| 464312 | 10-300 | | 5 | | 2 | | 3 | | 3 154144 643122 |

Essentials Pulse Soft 13 cm

- **Confort bi-material**
- **Seguridad:** cuchillas redondeadas
- **Hojas graduadas en cm**



464410



464412

| ref | */** | | | | | | | | |
|--------|--------|--|----|--|---|--|---|--|-----------------|
| 464410 | 24-480 | | 10 | | 8 | | 6 | | 3 154144 644105 |
| 464412 | 24-360 | | 10 | | 8 | | 6 | | 3 154144 644129 |

Essentials Soft Pastel 13 cm

- **Confort bi-material**
- **Seguridad:** cuchillas redondeadas
- **Hojas graduadas en cm**



464411



464413

| ref | */** | | | | | | | | |
|--------|--------|--|---|--|---|--|---|--|-----------------|
| 464411 | 24-480 | | 8 | | 8 | | 8 | | 3 154144 644112 |
| 464413 | 24-360 | | 6 | | 6 | | 6 | | 3 154144 644136 |

ESCOLAR



Security 13 cm

- **Security:** un sistema de bloqueo único de las cuchillas para una mayor seguridad
- **Uso escolar:** aros con ergonomía 3D para facilitar la empuñadura



473110



473190



473112

Zenoa Fit 13 cm

- **Material blando en el interior de los aros**
- **Relieves Soft:** sistema amortiguador antidolor



670110



670190



670112

| ref | e/.. | | | |
|--------|--------|--|-------|-----------------|
| 473110 | 12-144 | | 5 4 3 | 3 154144 731102 |
| 473190 | 12-144 | | | 3 154144 731904 |
| 473112 | 20-240 | | 8 8 4 | 3 154144 731126 |

| ref | e/.. | | | |
|--------|--------|--|-------|-----------------|
| 670110 | 12-144 | | 5 4 3 | 3 154146 701103 |
| 670190 | 12-144 | | | 3 154146 701905 |
| 670112 | 24-288 | | 9 9 6 | 3 154146 701127 |

Sensoft 13 cm

- Aros ergonómicos 3D para facilitar la empuñadura
- Confort óptimo: aros blandos



069300



484290



169300

| ref | */** | | | |
|--------|--------|--|-------|-----------------|
| 069300 | 12-144 | | 4 4 4 | 3 154140 693008 |
| 484290 | 12-144 | | | 3 154144 842907 |
| 169300 | 24-144 | | 6 9 9 | 3 154141 693007 |

Sensoft 13 cm - Zurdos

- Aros ergonómicos 3D para facilitar la empuñadura
- Confort óptimo: aros blandos
- Auténticas tijeras para zurdos: cuchillas invertidas



693500



484590



693501

| ref | */** | | | |
|--------|--------|--|-------|-----------------|
| 693500 | 12-144 | | 4 4 4 | 3 154146 935003 |
| 484590 | 12-144 | | | 3 154144 845908 |
| 693501 | 10-240 | | 2 4 4 | 3 154146 935010 |

Sensoft 13 cm - Asimétricas

- Diseño apto para zurdos y diestros
- Confort óptimo: aros blandos



484410



484490



484412

| ref | */** | | | |
|--------|--------|--|-------|-----------------|
| 484410 | 12-144 | | 4 4 4 | 3 154144 844109 |
| 484490 | 12-144 | | | 3 154144 844109 |
| 484412 | 24-288 | | 8 8 8 | 3 154144 844123 |

Sensoft Pastel 13 cm

- Aros ergonómicos 3D para facilitar la empuñadura
- Confort óptimo: aros blandos



484213



484291



484211

| ref | */** | | | |
|--------|--------|--|-------|-----------------|
| 484213 | 12-144 | | 4 4 4 | 3 154144 842136 |
| 484291 | 12-144 | | | 3 154144 842914 |
| 484211 | 24-144 | | 8 8 8 | 3 154144 842112 |

Tatoo Innovation 13 cm

- Diseño atractivo: aros con ergonomía, strass incrustados
- Durabilidad óptima de los motivos



| ref | e/.. | | | 3 154 144 700108 |
|--------|--------|---|---|------------------|
| 470010 | 12-144 | 8 | 4 | |

ESCOLAR

Estudiantes

- ▶ Una gama de tijeras desarrollada con la experiencia de una agencia de ergónomos para satisfacer las necesidades de todos.
- ▶ Nuestros productos son testados permanentemente para lograr cada vez mayor calidad y una durabilidad óptima de nuestras cuchillas

Pulse 16 cm

- Uso para estudiantes
- Cuchillas puntiagudas



476110



476112

Precise 13 cm

- Seguridad: estuche protector de las cuchillas
- Precisión: cuchillas puntiagudas



| ref | e/.. | | | 3 154 144 761109 |
|--------|--------|----|---|------------------|
| 476110 | 12-144 | 5 | 3 | 4 |
| 476112 | 24-144 | 10 | 6 | 8 |

| ref | e/.. | | | 3 154 146 817002 |
|--------|--------|--|--|------------------|
| 681700 | 12-144 | | | |

Zenoa Fit 15 cm

- Material blando en el interior de los aros
- Relieves soft: sistema amortiguador antidolor



Shape Smiling Planet 16 cm

- Aros fabricados con un 50% de fibra de madera con certificación FSC Mix, de bosques gestionados de forma responsable
- Ergonomía 3D para facilitar la empuñadura
- Embalaje de cartón reciclable



NEW!



Shape Smiling Planet 16 cm - Zurdos

- Aros fabricados con un 50% de fibra de madera con certificación FSC Mix, de bosques gestionados de forma responsable
- Ergonomía 3D para facilitar la empuñadura
- Embalaje de cartón reciclable



NEW!



Sensoft 16 cm

- Aros ergonómicos 3D para facilitar la empuñadura
- Confort óptimo: aros blandos



| ref | e/.. | | | |
|--------|--------|--|-------|------------------|
| 069600 | 12-144 | | 6 3 3 | 3 154 140 696009 |
| 486290 | 12-144 | | | 3 154 144 862905 |
| 169600 | 12-228 | | 6 3 3 | 3 154 141 696008 |



069600



486290



169600

Sensoft 16 cm - Zurdos

- Aros ergonómicos 3D para facilitar la empuñadura
- Confort óptimo: aros blandos
- Auténticas tijeras para zurdos: cuchillas invertidas



| ref | e/.. | | | |
|--------|--------|--|-------|------------------|
| 696510 | 12-144 | | 6 3 3 | 3 154 146 965109 |

Sensoft Pastel 16 cm

- Aros ergonómicos 3D para facilitar la empuñadura
- Confort óptimo: aros blandos



486214



486291

| ref | e/.. | | | |
|--------|--------|--|-------|------------------|
| 486214 | 12-144 | | 4 4 4 | 3 154 144 862141 |
| 486291 | 12-144 | | | 3 154 144 862912 |



Cortes creativos

- ▶ **Práctico:** lamas fácilmente intercambiables
- ▶ **Gran selección creativa:** 10 dibujos de lamas
- ▶ **Seguridad:** lamas de fibra de vidrio que no cortan ni la tela, ni los cabellos, ni la piel
- ▶ **Rendimiento:** corta el papel de 40 a 250 g

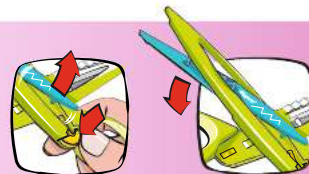

Creacut

- 5 composiciones disponibles



| ref | */** | | |
|--------|--------|--|--|
| 601003 | 12-144 | | |

CreaCut blíster 5 cuchillas

- **Contenido:** 1 par de tijeras y 5 cuchillas con diferentes cortes



| ref | */** | | |
|--------|------|--|--|
| 601006 | 8-48 | | |

Estuche

- **Contenido:** 1 montura de tijeras + 5 juegos de cuchillas intercambiables
- 2 composiciones surtidas



| ref | */** | | |
|--------|------|--|--|
| 601005 | 8-32 | | |

Maleta

- **Contenido:** 2 monturas de tijeras + 10 juegos de cuchillas intercambiables



| ref | */** | | |
|--------|------|--|--|
| 601010 | 12- | | |

Flautas de plástico

► **Pedagogía:** instrucciones para la digitación incluidas

Moderna

• **Cuidado fácil:** flauta desmontable, se entrega con una escobilla y un estuche

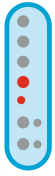

Barroca

• **Cuidado fácil:** flauta desmontable, se entrega con una escobilla y un estuche



Pizarras Kidy'Board

- **Innovación:** ¡Unas pizarras pedagógicas para que los niños aprendan!
- **¡Especial escuela infantil!** Juegos y ejercicios adaptados según la edad, reutilizables al infinito
- **Cuadro blando antideslizante**
- **Irrompible/anti-golpes:** pizarra 100% plástico flexible transparente



Transparente

- ¡La 1ª pizarra transparente educativa!
- Un contenido descargable en www.maped.com



Pizarras blancas y accesorios

► **Dos caras:** una lisa para dibujar, otra rayada para escribir

Irrompible

- Irrompible/anti choque: pizarra 100% plástico flexible
- Pizarra y porta accesorios fabricados completamente con material reciclado
- Ultra limpia/sin restos de trazos, con rotuladores borrables en seco Maped
- El porta accesorios se transforma en soporte para la pizarra

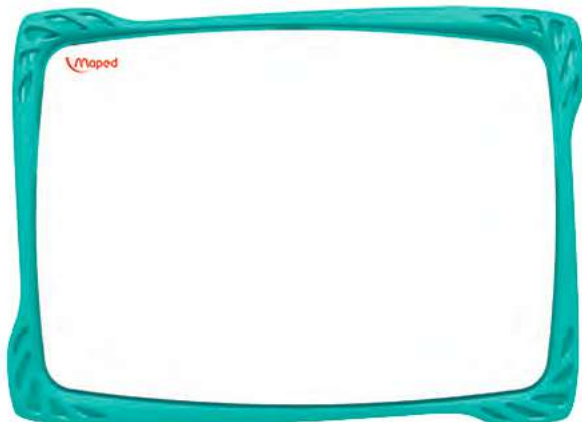

ESCOLAR

| ref | */** | | | | |
|--------|------|---|---|---|--|
| 583510 | 12- | | | | |
| | | 4 | 4 | 4 | |
| | | 1 pizarra + 1 porta-accesorios + 1 colgador + 1 rotulador borrable en seco azul | | | |
| | | | | | |

Classic blanca

- Hecho en Francia
- El marco contiene un 20% de plástico reciclado
- Sola o con paño y rotuladores de borrado en seco
- Embalaje de cartón reciclable

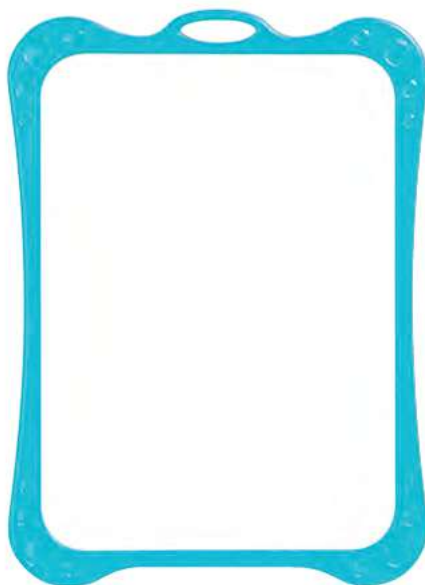

258510



258500

| ref | */** | | | | |
|--------|------|---|----|--|--|
| 258500 | 12- | | | | |
| | | 6 | 6 | | |
| | | 1 pizarra + 1 porta-accesorios + 1 colgador + 1 rotulador borrable en seco azul | | | |
| | | | | | |
| 258510 | 50- | | | | |
| | | 25 | 25 | | |
| | | Pizarra a granel | | | |
| | | | | | |

Pizarra Smiling Planet

- Hecho en Francia
- Pizarra 100% cartón
- Barniz resistente
- Borrado en seco
- 1 lado blanco y 1 lado cuadrículado

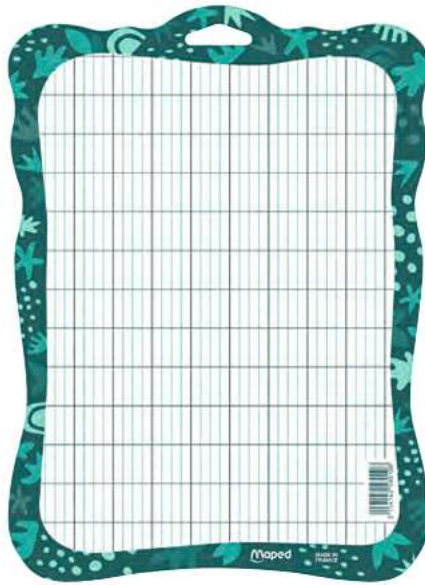

| ref | •/•• | | 3 154 142 580 108 |
|--------|------|--|-------------------|
| 258010 | -25 | | |

Marcadores y Rotuladores borrables en seco

- ▶ Una gama de rotuladores diseñada para dar respuesta a todas tus necesidades en el trabajo, el colegio y el hogar!
- ▶ Colores luminosos para un acabado de calidad

Rotuladores borrables en seco - Clásicos

- Se borran fácilmente, incluso después de varios días
- Olor neutro



| ref | •/•• | | 3 154 147 4 13 104 |
|----------|--------|---|--------------------|
| 741310LM | 12-144 | x2 | |
| 741311LM | 12-144 | x2 | |
| 741312LM | 12-144 | x4 | |
| 741815 | 12-144 | x5 + 1 balleta para borrar | 3 154 147 4 18 154 |
| 741830LM | 12-180 | x12 EAN 315414 741350 0 | |
| 741831LM | 12-180 | x12 EAN 315414 741351 7 | |
| 741804 | 4- | x168 rotuladores variados + 20 capuchones de recarga+ 20 balletas para borrar | |
| 741832LM | 12-180 | x12 | 3 154 147 4 18 321 |



741310LM



741311LM



741312LM



741815



741830LM



741831LM



741804



741832LM



Rotuladores borrables en seco Fun Colors

- 12 colores luminosos
- Se borran fácilmente, incluso después de varios días
- Olor neutro
- Disponible en estuche con cremallera o "innovación" para dejar de perder los tapones



| ref | */** | | |
|--------|-------|-----|--|
| 741817 | 12-96 | x12 | |
| 741845 | 12-72 | x12 | |



741817



741845

Marcadores de tiza - Multi-superficie borrable

- Para pizarras blancas o tableros, negro, vidrio, espejos, cerámica ...
- Pintura a base de agua
- Se borra con un paño húmedo
- Punta extraíble, reversible y lavable con agua tibia en caso de secado



| ref | */** | | |
|--------|--------|----|--|
| 743517 | 12-144 | x1 | |
| 743547 | 12-96 | x4 | |



743517



743547

Marcadores borrables en seco - Jumbo - Punta ojival

- Se borran fácilmente en cualquier superficie no porosa, incluso después de varias semanas
- Punta media bloqueada - 2 mm
- Seguridad: tapa ventilada



| ref | */** | | |
|--------|--------|-----|------------------|
| 735047 | 12-96 | | |
| | | x4 | 3 154 147 350478 |
| 735030 | 12-144 | | |
| | | x12 | 3 154 147 350300 |
| 735031 | 12-144 | | |
| | | x12 | 3 154 147 350317 |
| 735032 | 12-144 | | |
| | | x12 | 3 154 147 350324 |
| 735033 | 12-144 | | |
| | | x12 | 3 154 147 350331 |



735047



735030



735031



735032



735033

Marcadores borrables en seco - Jumbo - Punta Biselada

- Se borran fácilmente en cualquier superficie no porosa, incluso después de varias semanas
- Punta amplia bloqueada - 1 a 5 mm
- Seguridad: tapa ventilada



| ref | */** | | |
|--------|--------|-----|------------------|
| 735547 | 12-96 | | |
| | | x4 | 3 154 147 355473 |
| 735530 | 12-144 | | |
| | | x12 | 3 154 147 355305 |
| 735531 | 12-144 | | |
| | | x12 | 3 154 147 355312 |
| 735532 | 12-144 | | |
| | | x12 | 3 154 147 355329 |



735547



735530



735531



735532

Pizarras negras y accesorios

► **Dos caras:** una lisa para dibujar, otra rallada para escribir

Classic negra

- Más calidad: nuevo material
- Mejor capacidad de borrado
- Resistente al borrado con una esponja húmeda



258520



258530

| ref | */** | | |
|--------|------|--|--|
| 258520 | 50- |  6 6 Pizarra a granel |  |
| 258530 | 12- |  15 15 1 pizarra + 1 caja esponja + 10 tizas blancas |  |

Piedra natural



| ref | */** | | |
|--------|------|------------------|--|
| 258550 | 25- | Pizarra a granel |  |

Tizas

- Calidad superior: carbonato de calcio
- Manos limpias: fórmula sin polvo
- Colores luminosos: mayor visibilidad y legibilidad

| ref | */** | | |
|--------|--------|---|---|
| 593500 | 10-160 |  x10 |  |
| 593501 | 10-160 |  x10 Colores surtidos |  |
| 935020 | 1-16 |  x100 |  |
| 935021 | 1-16 |  10 Colores surtidos (100) |  |



593500



593501



935020



935021

Cepillos y esponjas

Cepillo Pelusa

- Cepillo de pelusa, pizarras y pizarras blancas
- Base microfibra, lavable a máquina

| ref | */** | | |
|--------|--------|--|---|
| 586110 | 12-144 | |  |



Cepillo magnético

- Cepillo de espuma ligera y resistente para pizarras y pizarras blancas
- Forma ergonómica
- Magnética: siempre a mano



| | | | |
|--------|--------|---|---|
| ref | e/.. | | |
| 586010 | 12-144 |   |  |
| | | | 3 154 145 860108 |

Cepillo estándar

- Cepillo de madera y fieltro delgado para pizarras y pizarras blancas



| | | | |
|--------|--------|---|---|
| ref | e/.. | | |
| 058700 | 12-300 |  |  |
| | | | 3 154 140 587000 |

Caja esponja

- Esponja para pizarras blancas y negras
- Forma triangular: facilita el borrado en las esquinas



| | | | |
|--------|--------|---|---|
| ref | e/.. | | |
| 258600 | 16-160 |  |  |
| | | | 3 154 142 586001 |

Paño

- Paño microfibra para pizarras y pizarras blancas
- Dimensiones: 20x20 cm

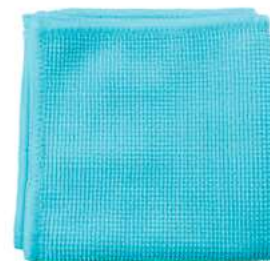

| | | | |
|--------|--------|---|---|
| ref | e/.. | | |
| 584610 | 24-120 |  |  |
| | | | 3 154 145 846102 |

ESCRITURA

INGENIOSO × IRRESISTIBLE × RESPONSABLE

Glitter

► Una gama decorada con efectos de purpurina que realzan los instrumentos de la escritura



Glitter - Black'Peps lápices de grafito - Con goma de borrar

- Lápices de grafito con cuerpo de purpurina
- Fabricados con un 41% de material reciclado y un 16% de material de origen natural
- Sin madera, fáciles de afilar
- Ergonomía: lápiz triangular para mejorar la sujeción



NEW!

| ref | */** | |
|--------|---------|--------|
| 851803 | 24-240 | x6 HB |
| 851804 | 12-1728 | x12 HB |
| 851805 | -20 | x72 HB |



851803



851804



851805

ETHIC

Glitter Reload - Plumas estilográficas

- ¡La estilográfica pluma Reload con colores metalizados!
- **Innovación:** sistema automático, fiable y rápido
- **Práctico:** reserva integrada
- **Calidad de escritura:** pluma de acero con punta de iridio



Glitter Reload - Roller

- ¡La estilográfica roller Reload con colores metalizados!
- **Innovación:** sistema automático, fiable y rápido
- **Práctico:** reserva integrada



| ref | •/•• | | ref | •/•• | |
|--------|--------|------------|------------------|------|--|
| 222702 | 12-120 | x1 4 4 4 4 | 3 154 142 227027 | | |

| ref | •/•• | | ref | •/•• | |
|--------|--------|------------|------------------|------|--|
| 221200 | 12-120 | x1 4 4 4 4 | 3 154 142 212009 | | |

Glitter Pastel - Subrayadores

- **Tendencia:** ¡los colores pastel más bonitos por fin están disponibles en versión brillante!
- **Comodidad:** punta biselada, trazo de 1 a 5 mm



742028

| ref | •/•• | | ref | •/•• | |
|--------|--------|--|------------------|------|--|
| 742028 | 12-120 | x2 - Colores surtidos | 3 154 147 420287 | | |
| 742046 | 12-180 | x4 | 3 154 147 420461 | | |
| 742038 | 12-144 | x3 EAN 315414 742036 2 x3 EAN 315414 742037 9 x3 EAN 315414 742030 0 x3 EAN 315414 742033 1 | | | |



742046



742038

Glitter Metal - Subrayadores

- **Elegancia:** ¡Cuatro nuevos colores metálicos brillantes! Oro, cobre, azul metálico y plata
- **Comodidad:** punta biselada, trazo de 1 a 5 mm



| ref | •/•• | | ref | •/•• | |
|--------|--------|----|------------------|------|--|
| 742000 | 12-180 | x4 | 3 154 147 420003 | | |

Black'Peps lápices de grafito (FSC Certificado)

- ▶ Una gama de lápices de grafito de madera con certificación FSC 100% de bosques gestionados de forma responsable
- ▶ Disponible solo en Francia



H



B



Clásico - Extremo pintado (FSC Certificado)



| ref | */** | | |
|----------|----------|----------------------------------|--|
| 850011FC | 24-432 | x3 HB Hasta finales de stocks | |
| 850017FC | 12-144 | x6 HB + 1 goma | |
| 850031FC | 24-240 | x6 HB Hasta finales de stocks | |
| 850022FC | 12-1728 | x12 2B | |
| 850024FC | 12-1728 | x12 B | |
| 850021FC | 12-1728 | x12 HB | |
| 850025FC | 12-1728 | x12 H | |
| 850023FC | 12-1728 | x12 2H | |
| 850059FC | -20 | x72 HB | |
| 850040FC | 100-1200 | x100 HB | |



850011FC



850017FC



850031FC



850022FC



850024FC



850021FC



850025FC



850023FC



850059FC



850040FC

Clásico - Con goma de borrar (FSC Certificado)



| ref | e/... | |
|----------|----------|-----------------------------------|
| 851711FC | 24-432 | x3 HB |
| 851731FC | 24-240 | x6 HB |
| 851732FC | 12-144 | x10 HB Hasta finales de stocks |
| 851722FC | 12-1728 | x12 2B |
| 851724FC | 12-1728 | x12 B |
| 851721FC | 12-1728 | x12 HB |
| 851725FC | 12-1728 | x12 H |
| 851723FC | 12-1728 | x12 2H Hasta finales de stocks |
| 851759FC | -20 | x72 HB |
| 851740FC | 100-1200 | x100 HB |



851711FC



851731FC



851732FC



851722FC



851724FC



851721FC



851725FC



851723FC



851759FC



851740FC

BLACK'PEPS

LA MEJOR FORMA DE SERA

CREATIVO

black'peps

black'peps

&black'peps

black'peps

ES REVELAR

TUS RASGOS
DE PERSONALIDAD

Black'Peps lápices de grafito

- ▶ Una gama de lápices de madera de alta calidad, elaborada para cumplir con todos los usos habituales de jóvenes y mayores
- ▶ Ergonomía: lápiz triangular para mejorar la sujeción
- ▶ Fáciles de afilar
- ▶ Mina resistente



Clásico - Extremo pintado

| ref | */** | | |
|--------|----------|---|--|
| 850011 | 24-432 | x3 HB - Disponible excepto para Francia | |
| 850031 | 24-240 | x6 HB - Disponible excepto para Francia | |
| 850032 | 12-144 | x10 HB - Disponible excepto para Francia | |
| 850022 | 12-1728 | x12 2B - Disponible excepto para Francia | |
| 850024 | 12-1728 | x12 B - Disponible excepto para Francia | |
| 850021 | 12-1728 | x12 HB | |
| 850025 | 12-1728 | x12 H - Disponible excepto para Francia | |
| 850023 | 12-1728 | x12 2H - Disponible excepto para Francia | |
| 850059 | -20 | x72 HB - Disponible excepto para Francia | |
| 850040 | 100-1200 | x100 HB - Disponible excepto para Francia | |



850011



850031



850032



850022



850024



850021



850025



850023



850059



850040

Clásico - Con goma de borrar



| ref | */** | | |
|--------|----------|--|--|
| 851711 | 24-432 | x3 HB - Disponible excepto para Francia | |
| 851712 | 24-432 | x3 2B - Hasta finales de stocks | |
| 851731 | 24-288 | x6 HB - Disponible excepto para Francia | |
| 851732 | 12-144 | x10 HB - Disponible excepto para Francia | |
| 851722 | 12-1728 | x12 2B - Disponible excepto para Francia | |
| 851724 | 12-1728 | x12 B - Disponible excepto para Francia | |
| 851721 | 12-1728 | x12 HB - Disponible excepto para Francia | |
| 851725 | 12-1728 | x12 H - Disponible excepto para Francia Hasta finales de stocks | |
| 851723 | 12-1728 | x12 2H - Disponible excepto para Francia | |
| 851759 | -20 | x72 HB - Disponible excepto para Francia | |
| 851740 | 100-1200 | x100 HB - Disponible excepto para Francia Hasta finales de stocks | |



851711



851712



851731



851732



851722



851724



851721



851725



851723



851759



851740

Mini Black'Peps

- Práctico: formato mini adaptado a compases con abrazadera
- Ganancia de espacio en el estuche



| ref | */** | | |
|--------|--------|------------|--|
| 850211 | 24-432 | x3 Mini HB | |



Black'Peps lápices de grafito decorados

- ▶ ¡Una gama de lápices de grafito decorados, con varios temas para todos los gustos!
- ▶ Ergonomía: lápiz triangular para mejorar la sujeción



Energy - Con goma de borrar

- Lápices de resina
- Fabricados con 38.7% de residuos post-industriales
- Una gama de lápices de grafito personalizados con un mensaje
- Un cuerpo de color negro supermoderno
- ¡Escoge el mensaje que te ponga las pilas y refleje tu estado de ánimo del momento!



| ref | u/.. | | |
|--------|---------|---|------------------|
| 852000 | 24-240 | | |
| | | x6 HB | 3 154 148 520009 |
| 852001 | 12-1728 | | |
| | | x12 HB Embalaje de cartón reciclable | 3 154 148 520016 |
| 852002 | -20 | | |
| | | x72 HB | 3 154 148 520023 |



852000



852001



852002



Pastel - Con goma de borrar

- Lápices de madera de calidad
- Tendencia : los colores pastel más bonitos



| ref | u/.. | | |
|--------|---------|--------|------------------|
| 851719 | 24-432 | | |
| | | x3 HB | 3 154 148 517191 |
| 851730 | 12-1728 | | |
| | | x12 HB | 3 154 148 517306 |
| 851769 | -20 | | |
| | | x72 HB | 3 154 148 517696 |



851719



851730



851769

Deco - Punta pintada

- Lápices de madera de calidad
- Hasta finales de stocks





850018



850060



| ref | */** | | |
|--------|---------|---|---|
| 850018 | 24-432 |  |  |
| | | x3 HB | 3 154148 500186 |
| 850060 | 12-1728 |  |  |
| | | x12 HB | 3 154148 500605 |

Deco - Con goma de borrar

- Lápices de madera de calidad
- Hasta finales de stocks



851718



851760



| ref | */** | | |
|--------|---------|---|---|
| 851718 | 24-432 |  |  |
| | | x3 HB | 3 154148 517184 |
| 851760 | 12-1728 |  |  |
| | | x12 HB | 3 154148 517603 |

Black'Peps Jumbo lápices de grafito

- ▶ Lápices de madera de calidad
- ▶ Ideal para aprender a escribir
- ▶ Diámetro grueso: Ø 4.7 mm, un empuñadura en la mano fácil para los más jóvenes
- ▶ Mina amplia y resistente



Jumbo - Extremo pintado

| ref | */** | | |
|--------|---------|---|--|
| 854041 | 12-288 | x2 HB + sacapuntas grande orificio Hasta finales de stocks |  |
| 854021 | 12-1728 | x12 HB |  |
| 854059 | -20 | x46 HB |  |



854041





854021



854059

Jumbo - Con goma de borrar



| ref | */** | | |
|--------|---------|------------------------------------|---|
| 854741 | 12-288 | x2 HB + sacapuntas grande orificio |  |
| 854721 | 12-1728 | x12 HB |  |
| 854759 | -20 | x46 HB |  |



854741



854721



854759

Black'Peps lápices Navy

► Una gama de lápices de resina de alta calidad, elaborados para cumplir con todos los usos habituales de jóvenes y mayores



Clásico - Extremo cortada



| ref | */** | | ETHIC | 3 154148 508212 |
|--------|---------|--|-------|-----------------|
| 850821 | 12-1728 | x12 HB Fabricados con un 47% de material reciclado Embalaje de cartón reciclable | | 3 154148 508212 |
| 850822 | 12-1728 | x12 2B | | 3 154148 508229 |
| 850859 | -20 | x72 HB | | 3 154148 508595 |
| 850811 | 24-432 | x3 HB Hasta finales de stocks | | 3 154148 508113 |
| 850831 | 24-240 | x6 HB Hasta finales de stocks | | 3 154148 508311 |



850859



850821



850822



850811



850831

Clásico - Con goma de borrar



| ref | */** | | ETHIC | 3 154148 518211 |
|--------|---------|--|-------|-----------------|
| 851821 | 12-1728 | x12 HB Fabricados con un 40.9% de material reciclado Embalaje de cartón reciclable | | 3 154148 518211 |
| 851822 | 12-1728 | x12 2B | | 3 154148 518228 |
| 851859 | -20 | x72 HB | | 3 154148 518594 |
| 851811 | 24-432 | x3 HB Hasta finales de stocks | | 3 154148 518112 |
| 851831 | 24-240 | x6 HB Hasta finales de stocks | | 3 154148 518310 |



851859



851821



851822



851811



851831

Lápices de corrección

- ▶ Lápices de madera de alta calidad, elaborada para cumplir con todos los usos habituales de jóvenes y mayores
- ▶ Para checar, subrayar y marcar



Checking pencil - Con goma de borrar

- Mina suave y resistente
- Punta borrador para borrar el grafito
- Agarre triangular



| ref | */** | | |
|--------|---------|---|---|
| 838510 | 12-1728 |  |  |
| | | x12 | 3 154148 385103 |

Black'Peps portaminas

- ▶ Una gama de portaminas y estuches de minas de calidad, fiables, capaces de combinar diseño y eficacia
- ▶ 2 sistemas innovadores: automático o recarga fácil
- ▶ Mina: 0.5 o 0.7 mm alto polímero HB, más resistente que una mina tradicional



Estuches de minas Black'Peps

- Estuches de 12 minas para recargar los portaminas
- Minas alto polímero, más resistentes que las minas tradicionales

| ref | */** | | |
|--------|--------|---|---|
| 559610 | 12-240 | x2 - Inner decorado - 0.5 HB |  |
| 559630 | 12-384 | x12 HB 0.5 mm |  |
| 560410 | 12-240 | x2 - Inner decorado - 0.7 HB |  |
| 560430 | 12-384 | x12 HB 0.7 mm |  |
| 897523 | 1-8 | x144 estuches x12 EAN 315414 559633 5 (0.5 - 2H) x12 EAN 315414 559637 3 (0.5 - H) x24 EAN 315414 559630 4 (0.5 - HB) x12 EAN 315414 559632 8 (0.5 - B) x12 EAN 315414 559635 9 (0.5 - 2B) x12 EAN 315414 560433 7 (0.7 - 2H) x12 EAN 315414 560437 5 (0.7 - H) x24 EAN 315414 560430 6 (0.7 - HB) x12 EAN 315414 560432 0 (0.7 - B) x12 EAN 315414 560435 1 (0.7 - 2B) |  |



559610



559630



560410



560430



897523

Long Life 0.5

- 50% más de minas que en un porta-minas estándar
- Comodidad: presión blanda antideslizante



564053



564040



| ref | */** | | |
|--------|--------|--|-----------------|
| 564053 | 14-168 | | |
| | | x3 | 3 154145 640533 |
| 564040 | 36-432 | | |
| | | x36 x12 EAN 315414 564030 4 x12 EAN 315414 564033 5 x12 EAN 315414 564036 6 | |

Long Life 0.7

- 50% más de minas que en un porta-minas estándar
- Comodidad: presión blanda antideslizante



564153



564140



| ref | */** | | |
|--------|--------|--|-----------------|
| 564153 | 14-168 | | |
| | | x3 | 3 154145 641530 |
| 564140 | 36-432 | | |
| | | x36 x12 EAN 315414 564130 1 x12 EAN 315414 564133 2 x12 EAN 315414 564136 3 | |

Automático 0.5

- Mecanismo automático que permite la extracción continua de la mina sin esfuerzo: no hay que presionar una y otra vez
- Comodidad: presión blanda antideslizante
- Cañón retráctil



| ref | */** | | |
|--------|--------|--|-----------------|
| 559511 | 12-120 | | |
| | | x1 + 1 estuche de minas | 3 154145 595116 |
| 559553 | 12-144 | | |
| | | x3 | 3 154145 595536 |
| 559530 | 12-216 | | |
| | | x12 | 3 154145 595307 |
| 559533 | 12-216 | | |
| | | x12 - Hasta finales de stocks | 3 154145 595338 |
| 559541 | 36-288 | | |
| | | x36 x12 EAN 315414 559530 7 x12 EAN 315414 559533 8 x12 EAN 315414 559536 9 | |



559511



559553



559530



559533



559541

Automatic 0.7

- Mecanismo automático que permite la extracción continua de la mina sin esfuerzo: no hay que presionar una y otra vez
- Comodidad: presión blanda antideslizante
- Cañón retráctil



| ref | •/•• | | |
|--------|--------|--|-----------------|
| 559911 | 12-120 | x1 + 1 estuche de minas | 3 154145 599114 |
| 559930 | 12-216 | x12 | 3 154145 599305 |
| 559933 | 12-216 | x12 - Hasta finales de stocks | 3 154145 599336 |
| 559936 | 12-216 | x12 - Hasta finales de stocks | 3 154145 599367 |
| 559941 | 36-288 | x36 x12 EAN 315414 559930 5 x12 EAN 315414 559933 6 x12 EAN 315414 559936 7 | |



559911



559930



559933



559936



559941

Rotuladores medium

- ▶ ¡La última incorporación de la familia Graph'peps, el bolígrafo de escritura de punta media, es ya un imprescindible!
- ▶ Llévalo a todos lados... ¡Al colegio, al trabajo, y haz que tu escritura sea más viva gracias a nuestra paleta de colores vibrantes!



Graph'Peps Deco

- 12 colores vibrantes
- Fiabilidad: la tinta no traspasa el papel
- Calidad: punta media 0.8 mm, suave y resistente
- Confort: empuñadura triangular para una sujeción óptima

| ref | •/•• | | |
|--------|--------|------------------------------|-----------------|
| 749620 | 12-144 | x1 - Hasta finales de stocks | 3 154147 496206 |
| 749602 | 12-144 | x2 NEW! | 3 154147 496022 |
| 749627 | 12-144 | x4 - Hasta finales de stocks | 3 154147 496275 |
| 749652 | 8-96 | x12 | 3 154147 496527 |



749620



749602



749627



749652







Rotuladores de punta fina

- Una gama universal de rotuladores para todos los usuarios, pequeños o grandes, que quieran embellecer su escritura, dibujar con precisión... ¡o sencillamente dar rienda suelta a su inspiración!



Graph'Peps Deco

- 20 colores vibrantes
- **Fiabilidad:** la tinta no traspasa el papel
- **Calidad:** punta fina 0,4 mm, suave y resistente
- **Confort:** empuñadura triangular para una sujeción óptima

| ref | */** | | |
|--------|--------|---|-----------------|
| 749040 | 12-144 |  | 3 154147 490402 |
| 749041 | 12-144 |  | 3 154147 490419 |
| 749044 | 12-144 |  | 3 154147 490440 |
| 749043 | 12-144 |  | 3 154147 490433 |



749040



749041



749044



749043

| ref | */** | | |
|--------|--------|---|--|
| 749020 | 8-64 |  x4 - Inner decorado Hasta finales de stocks |  3 154147 490204 |
| 749048 | 12-144 |  x8 |  3 154147 490488 |
| 749050 | 8-96 | x10 |  3 154147 490501 |
| 749051 | 6-72 | x20 |  3 154147 490518 |



749040



749041



749044











749043

Graph'Peps Deco - Cajas

- 4 colores vibrantes
- **Fiabilidad:** la tinta no traspasa el papel
- **Calidad:** punta media 0.8 mm, suave y resistente
- **Confort:** empuñadura triangular para una sujeción óptima



| ref | */** | | |
|--------|--------|--|--|
| 749000 | 12-288 |  x12 - Dark Black |  3 154147 490006 |
| 749001 | 12-288 |  x12 - Marina Blue |  3 154147 490013 |
| 749002 | 12-288 |  x12 - Red Kiss |  3 154147 490020 |
| 749003 | 12-288 |  x12 - Green Golf |  3 154147 490037 |



749000



749001





749002



749003

Graph'Peps Classic

- 20 colores vibrantes
- Calidad: punta de metal japonesa
- Precisión: 0,4 mm punta de rotuladores
- Confort: empuñadura triangular para una sujeción óptima

| ref | */** | | |
|--------|--------|---|---|
| 749140 | 12-144 |   x2 - Hasta finales de stocks |  3 154147 491409 |
| 749141 | 12-144 |   x2 |  3 154147 491416 |
| 749143 | 12-144 |     x4 |  3 154147 491430 |
| 749144 | 12-144 |     x4 |  3 154147 491447 |
| 749150 | 6-60 | x10 |  3 154147 491508 |
| 749151 | 6-30 | x20 |  3 154147 491515 |
| 749158 | 12-72 | x12 - Bolsa stand up Hasta finales de stocks |  3 154147 491584 |



749140



749141



749144



749143



749150





















749151



749158

Graph'Peps Classic - Cajas

- 6 colores vibrantes
- Calidad: punta de metal japonesa
- Precisión: 0,4 mm punta de rotuladores
- Confort: empuñadura triangular para una sujeción óptima

| ref | */** | | |
|--------|--------|---|---|
| 749111 | 12-288 |   x12 - Dark Black - 01 |  3 154147 491119 |
| 749117 | 12-288 |   x12 - Red Kiss - 08 Hasta finales de stocks |  3 154147 491171 |
| 749120 | 12-288 |   x12 - Marina Blue - 05 |  3 154147 491201 |
| 749105 | 12-288 |   x12 - Blue Lagoon - 15 |  3 154147 491058 |
| 749118 | 12-288 |   x12 - Lovely Pink - 27 |  3 154147 491188 |
| 749108 | 12-288 |   x12 - Sweety Purple - 07 |  3 154147 491089 |



749111



749117



749120



749105



749118



749108

Graph'Peps - Compact

- ¡Todas las ventajas de los des rotuladores Graph'Peps juntos en una caja innovadora!
- **Sostenible:** caja de plástico
- **Nómada:** volumen mínimo
- **Práctico:** caja caballete
- ¡10 colores vivos disponibles!

COMPACT



| ref | e/.. | | |
|--------|------|----------------|---|
| 749155 | 6-72 | Inner decorado |  |

Graph'Peps Duo

- ¡Todas las ventajas de los rotuladores Graph'Peps en un Duo para crear!
- **Calidad:** punta de metal japonesa
- **Listo & práctico:** 2 veces más de colores
- **Único:** ¡personalice & cree sus propios duos!
- 10 colores vivos disponibles en 5 rotuladores Duo!



| ref | e/.. | | |
|--------|-------|-----------------------------------|---|
| 749250 | 12-96 | 5 Duo = 10 colores Inner decorado |  |

Graph'Mania

- ¡Ideal para los maníacos de la personalización y la valorización de los escritos!
- 24 plantillas diferentes para dar formas y colores a su imaginación
- Plantillas adaptables a los Graph' Peps Dúo para una amplia elección de colores y creaciones



| ref | e/.. | | |
|--------|------|--|---|
| 749450 | 6-72 | x10 - Inner decorado Hasta finales de stocks |  |

Graph'Peps - Kit de colores

- ¡Todas las ventajas de los des rotuladores Graph'Peps juntos en un kit!
- 33 piezas: 10 rotuladores Brush + 10 Graph'Peps + 12 lápices Duo + 1 sacapuntas



| ref | e/.. | | |
|--------|------|-----|---|
| 897417 | 6-24 | x33 |  |

Twin Tip 4

- ▶ **Innovación:** ¡El primer bolígrafo de 4 colores con 2 puntas!
- ▶ **Doble punta para usar dos colores al mismo tiempo**



medium

Twin Tip 4 - Classic

- ¡El original!
- **Fiabilidad:** escritura suave y regular
- **Confort:** doble sujeción suave hasta la punta, para un empuñadura estable y con un confort óptimo



| ref | */** | | |
|--------|--------|-----|------------------|
| 229120 | 12-144 | | |
| | | x1 | 3 154 142 291202 |
| 229130 | 12-216 | | |
| | | x12 | 3 154 142 291301 |



229120



229130

Ball'Peps

- ▶ **Calidad premium:** escritura extra suave y regular
- ▶ **Comodidad de escritura:** empuñadura triangular



Ice

- Fabricados con un 80% de plástico reciclado post-industrial
- Innovación diseño: efecto 3D carbono para un look muy alternativo
- Especialmente concebidos para jóvenes
- Punta media 1 mm
- Sólo existe en : NO REACH. (Disponible excepto para Francia)



medium

| ref | */** | |
|----------|--------|----------------------|
| 224434NE | 12-288 | x12 EAN 30102507 |
| 224435NE | 12-288 | x12 EAN 30102491 |
| 224436NE | 12-288 | x12 EAN 30102484 |
| 224430NE | 50-600 | x50 EAN 30102507 |
| 224431NE | 50-600 | x50 EAN 30102491 |
| 224432NE | 50-600 | x50 EAN 30102484 |



224434NE



224435NE



224436NE



224430NE



224431NE



224432NE

ETHIC

Dark

- Fabricados con un 80% de plástico reciclado post-industrial
- Innovación diseño: efecto 3D carbono para un look moderno
- ¡Señala tu diferencia!
- Punta media 1 mm
- Sólo existe en : NO REACH. (Disponible excepto para Francia)



medium



Visio Pen - Zurdos

- El 1er bolígrafo ergonómico que permite una correcta visibilidad a los zurdos: forma adaptada y una posición de la punta que permite aumentar la visibilidad
- Comodidad: presión blanda antideslizante en toda la superficie del bolígrafo y presión ideal, guiado pero no forzado
- Punta media



| ref | •/•• | |
|----------|--------|------------------|
| 225430NE | 50-600 | x50 EAN 30098749 |

| ref | •/•• | |
|--------|--------|----|
| 224320 | 12-144 | x1 |



Calligraph'Peps

- ▶ Práctico: recargable con cartuchos estándares
- ▶ Borrable: con un borrar-reescribir
- ▶ Diseño: formas y colores que gustan a los niños
- ▶ Escritura ultra suave y regular



ESCRITURA

Classic - Plumas estilográficas

- Calidad de escritura: pluma de acero con punta de iridio que garantiza un deslizamiento excelente y regularidad en la escritura
- Visibilidad de nivel de tinta
- Práctica: personalización de la pluma (nombre del niño)

IRIDIUM



222210



222212



| ref | •/•• | |
|--------|--------|--------|
| 222210 | 12-144 | x1 6 6 |



Classic - Roller

- Confort: escritura ultra fluida y regular
- Visibilidad de nivel de tinta

medium



| ref | •/•• | |
|--------|--------|-----------------------------|
| 221310 | 12-144 | x1 + borrador + 2 cartuchos |





Reload - Plumas estilográficas

- El sistema de carga de cartuchos más fiable y rápido: ¡la pluma se carga con un solo clic!
- **Innovación:** sistema automático, fiable, rápido y limpio
- **Práctico:** reserva integrada
- **Calidad de escritura:** pluma de acero con punta de iridio

IRIDIUM



Reload - Roller

- El sistema de carga de cartuchos más fiable y rápido: ¡la pluma se carga con un solo clic!
- **Innovación:** sistema automático, fiable, rápido y limpio
- **Práctico:** reserva integrada



Reload - Plumas estilográficas Premium

- El sistema de carga de cartuchos más fiable y rápido: ¡la pluma se carga con un solo clic!
- **Innovación:** sistema automático, fiable, rápido y limpio
- **Práctico:** reserva integrada
- **Calidad de escritura:** pluma de acero con punta de iridio

IRIDIUM

| ref | e/.. | Hasta finales de stocks | | 3 154 142 22720 1 |
|--------|--------|-------------------------|---|-------------------|
| 222720 | 12-120 | 6 | 6 | |

Reload - Roller Premium

- El sistema de carga de cartuchos más fiable y rápido: ¡la pluma se carga con un solo clic!
- **Innovación:** sistema automático, fiable, rápido y limpio
- **Práctico:** reserva integrada



| ref | e/.. | Hasta finales de stocks | | 3 154 142 21220 7 |
|--------|--------|-------------------------|---|-------------------|
| 221220 | 12-120 | 6 | 6 | |

Accesorios de escritura

► **Imprescindibles en todos los kits:** el borrador estándar o mini y cartuchos para plumas estilográficas y roller recargables

Borradores

- Punta biselada, para un borrado ancho o fino
- Para tinta azul que pueda borrarse



| ref | e/.. | Hasta finales de stocks | | 3 154 140 12802 9 |
|--------|---------|-------------------------|--|-------------------|
| 012802 | 50-300 | x2 | | |
| 012806 | 50-200 | x6 | | 3 154 140 12806 7 |
| 128010 | 50-1200 | x50 | | 3 154 141 28010 8 |



012802



012806



128010



Cartuchos

- Cartuchos de tinta estándar, azul, borrable
- Ideal para plumas estilográficas o rollers con cartucho

| ref | e/.. | Hasta finales de stocks | | 3 154 142 21910 7 |
|--------|--------|-------------------------|--|-------------------|
| 221910 | 12-120 | x20 | | |



Fluo Peps

- ▶ ¡Colores brillantes para resaltar sus textos!
- ▶ **Fiabilidad:** flujo regular de tinta
- ▶ **Aplicable a todo tipo de papel:** normal, fotocopias, fax ...
- ▶ **Fotocopia/Fax:** texto legible para todos los colores, excepto violeta



Flex Pastel

- **Innovación mundial:** punta ligera flexible para una sensación única ideal para embellecer las notas
- **Deslizamiento y precisión**
- **Comodidad:** punta biselada, trazo de 1 a 5 mm



740308



740308



740310

| ref | */** | | |
|--------|--------|--|-----------------|
| 740308 | 12-180 | | |
| | | x4 - Colores surtidos | 3 154147 403082 |
| 740310 | 24-144 | | |
| | | x4 EAN 315414 740311 2 x4 EAN 315414 740315 0 x4 EAN 315414 740316 7 x4 EAN 315414 740317 4 x4 EAN 315414 740314 3 x4 EAN 315414 740313 6 | |

Flex

- **Innovación mundial:** punta ligera flexible para una sensación única
- **Deslizamiento y precisión**
- **Comodidad:** punta biselada, trazo de 1 a 5 mm



740300

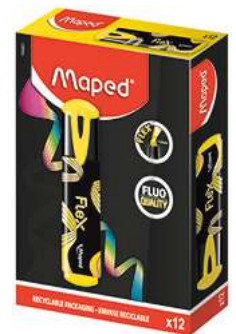

740301



| ref | */** | | |
|--------|--------|--|-----------------|
| 740300 | 12-180 | | |
| | | x4 | 3 154147 403006 |
| 740301 | 12-144 | | |
| | | x12 | 3 154147 403013 |
| 740302 | 24-144 | | |
| | | x8 EAN 315414 740301 3 x4 EAN 315414 740305 1 x4 EAN 315414 740303 7 x4 EAN 315414 740306 8 x4 EAN 315414 740304 4 | |



740302

Classic

- Comodidad: punta biselada, trazo de 1 a 5 mm
- Embalaje de cartón reciclable



742524



742567



742549



742547



742557

| ref | u/... | | |
|--------|--------|--|--------------------|
| 742524 | 12-144 | x1 | 3 154 147 4 252 44 |
| 742567 | 12-120 | x2 Hasta finales de stocks | 3 154 147 4 256 71 |
| 742549 | 12-180 | x4 | 3 154 147 4 254 97 |
| 742547 | 12-180 | x4 | 3 154 147 4 254 73 |
| 742557 | 12-120 | x6 | 3 154 147 4 255 72 |
| 742534 | 12-144 | x12 | 3 154 147 4 253 43 |
| 742535 | 12-144 | x12 | 3 154 147 4 253 50 |
| 742533 | 12-144 | x12 | 3 154 147 4 253 36 |
| 742536 | 12-144 | x12 | 3 154 147 4 253 67 |
| 742530 | 12-144 | x12 | 3 154 147 4 253 05 |
| 742531 | 12-144 | x12 | 3 154 147 4 253 12 |
| 742537 | 28-168 | x8 EAN 315414 742534 3 x4 EAN 315414 742535 0 x4 EAN 315414 742533 6 x4 EAN 315414 742536 7 x4 EAN 315414 742530 5 x4 EAN 315414 742531 2 | |



742534



742535



742533



742536



742530



742531



742537

Classic Pastel

- **Tendencia:** los colores pastel más bonitos
- **Comodidad:** punta biselada, trazo de 1 a 5 mm
- **Embalaje de cartón reciclable**



| ref | */** | | |
|--------|--------|--|-----------------|
| 742528 | 12-120 | x2 - Colores surtidos | 3 154147 425282 |
| 742546 | 12-180 | x4 | 3 154147 425466 |
| 742558 | 12-120 | x6 | 3 154147 425589 |
| 742570 | 12-144 | x12 | 3 154147 425701 |
| 742571 | 12-144 | x12 | 3 154147 425718 |
| 742576 | 12-144 | x12 | 3 154147 425763 |
| 742538 | 24-144 | x4 EAN 315414 742594 7 x4 EAN 315414 742595 4 x4 EAN 315414 742596 1 x4 EAN 315414 742597 8 x4 EAN 315414 742599 2 x4 EAN 315414 742593 0 | |



742528



742546



742558



742570



742571



742576



742538

Surtidos

- **Packs que reúnen numerosos colores y efectos de subrayadores para embellecer las notas**
- **Comodidad:** punta biselada, trazo de 1 a 5 mm
- **Embalaje de cartón reciclable**



740901

| ref | */** | | |
|--------|--------|---|-----------------|
| 740901 | 8-80 | x12 | 3 154147 409015 |
| 740902 | 12-180 | OCEANO : TROPICAL : PUESTA DE SOL : x4 cuyo 2 glitter - Colores surtidos | 3 154147 409022 |



740902



740902



740902

Fluo Duo

- **Formato dúo:** un subrayador, dos puntas de color diferente
- **Comodidad:** punta biselada, trazo de 1 a 5 mm
- **Económico:** longitud de escritura un 30% superior a un subrayador clásico
- **Embalaje de cartón reciclable**



| ref | */** | | |
|--------|--------|-----|-----------------|
| 734127 | 12-144 | x3 | 3 154147 341278 |
| 734128 | 12-144 | x3 | 3 154147 341285 |
| 734133 | 12-144 | x12 | 3 154147 341339 |
| 734135 | 12-144 | x12 | 3 154147 341353 |
| 734136 | 12-144 | x12 | 3 154147 341360 |



734127



734128



734133



734135



734136

Pen

- **Comodidad:** punta biselada, trazo de 1 a 5 mm
- **Formato bolígrafo:** ideal para el estuche



| ref | */** | | |
|--------|--------|-------------------------------|-----------------|
| 734027 | 12-96 | x5 | 3 154147 340271 |
| 734034 | 12-144 | x12 | 3 154147 340349 |
| 734035 | 12-144 | x12 - Hasta finales de stocks | 3 154147 340356 |
| 734033 | 12-144 | x12 - Hasta finales de stocks | 3 154147 340332 |
| 734036 | 12-144 | x12 - Hasta finales de stocks | 3 154147 340363 |



734027



734034



734035



734033







734036

Max

- **Comodidad:** punta biselada, trazo de 1 a 5 mm
- **Formato maxi:** longitud de escritura superior a un subrayador estándar
- **Ergonómico:** empuñadura triangular soft



| ref | */** | | |
|--------|--------|--|-----------------|
| 742924 | 12-84 |  x1 - Hasta finales de stocks | 3 154147 429242 |
| 742947 | 12-96 |  x4 | 3 154147 429471 |
| 742934 | 10-240 |  x10 - Hasta finales de stocks | 3 154147 429341 |
| 742937 | 24-144 |  x8 EAN 315414 742934 1 x4 EAN 315414 742935 8 x4 EAN 315414 742933 4 x4 EAN 315414 742936 5 x4 EAN 315414 742930 3 Hasta finales de stocks | |



742924



742947



742934









742937

Pocket Soft

- ¡Formato mini, especial para el estuche!
- Colores que gustan a los jóvenes
- **Comodidad:** punta biselada, trazo de 1 a 5 mm



| ref | */** | | |
|--------|--------|--|-----------------|
| 742777 | 12-144 |  x4 | 3 154147 427774 |
| 742730 | 12-144 |  x12 - Hasta finales de stocks | 3 154147 427309 |
| 742733 | 12-144 |  x12 - Hasta finales de stocks | 3 154147 427330 |
| 742734 | 12-144 |  x12 - Hasta finales de stocks | 3 154147 427347 |
| 742735 | 12-144 |  x12 - Hasta finales de stocks | 3 154147 427354 |
| 742728 | 12-144 |  x5 | 3 154147 427286 |
| 742737 | 48-240 |  x16 EAN 315414 742734 7 x8 EAN 315414 742735 4 x8 EAN 315414 742733 0 x8 EAN 315414 742736 1 x8 EAN 315414 742730 9 | |



742777



742730



742733



742734



742735



742728



742737

Ultra Soft Transparente

- La innovación del ultra soft, ¡con un nuevo cuerpo transparente!
- Hasta finales de stocks



| ref | e/** | | |
|--------|--------|--|------------------|
| 745947 | 12-180 | | |
| | | x4 | 3 154 147 459478 |
| 745937 | 24-144 | | |
| | | x8 EAN 315414 745934 8 x4 EAN 315414 745935 5 x4 EAN 315414 745936 2 x4 EAN 315414 745933 1 x4 EAN 315414 745930 0 | |



745947



745937

Roller

- **Innovación mundial:** subrayador roller, tecnología de sello continuo
- **Calidad:** trazo limpio y regular
- **Fiabilidad:** utilizable sobre todo tipo de tintas (rotulador, plumas...)
- **Durabilidad:** no se seca sin tapa
- Hasta finales de stocks



| ref | e/** | | |
|--------|--------|--|------------------|
| 746325 | 12-120 | | |
| | | x1 | 3 154 147 463253 |
| 746326 | 12-120 | | |
| | | x1 | 3 154 147 463260 |
| 746337 | 10-70 | | |
| | | x2 EAN 315414 746334 5 x2 EAN 315414 746335 2 x2 EAN 315414 746336 9 x2 EAN 315414 746333 8 x2 EAN 315414 746330 7 | |



746325



746326



746337

Marcadores permanentes

- ▶ Ideal para todo tipo de usos, tanto en el trabajo como en el hogar
- ▶ Escribe sobre la mayoría de las superficies: cartón, madera, papel, plástico, metal...
- ▶ Colores vivos y luminosos

Clásico

- 12 colores vivos y brillantes
- Alta durabilidad y resistencia en todas las superficies, la tinta se seca rápidamente.
- Perfecto para personalizar tus objetos cotidianos!
- Comodidad: punta oval fina, línea de 1 mm
- Vida media antes del secado = 20 días - según prueba interna



| ref | e/** | | |
|--------|--------|------------------------------|------------------|
| 734510 | 12-144 | | |
| | | x1 - Hasta finales de stocks | 3 154 147 345108 |
| 734511 | 12-144 | | |
| | | x1 | 3 154 147 345115 |
| 734517 | 12-96 | | |
| | | x4 | 3 154 147 345177 |
| 734547 | 12-72 | | |
| | | x12 - Colores surtidos | 3 154 147 345474 |
| 734530 | 12-144 | | |
| | | x12 | 3 154 147 345306 |
| 734531 | 12-144 | | |
| | | x12 | 3 154 147 345313 |



734510



734511



734517



734547



734530



734531

Jumbo - Punta Ojival

- Escribe sobre la mayoría de las superficies: cartón, madera, papel, plástico, metal...
- Punta media bloqueada - 2 mm
- Seguridad: tapa ventilada
- Hasta finales de stocks



| ref | **/** | | |
|--------|--------|-----|-----------------|
| 733047 | 12-96 | | |
| | | x4 | 3 154147 330470 |
| 733030 | 12-144 | | |
| | | x12 | 3 154147 330302 |
| 733031 | 12-144 | | |
| | | x12 | 3 154147 330319 |
| 733032 | 12-144 | | |
| | | x12 | 3 154147 330326 |
| 733033 | 12-144 | | |
| | | x12 | 3 154147 330333 |



733047



733030



733031



733032



733033

Jumbo - Punta Biselada

- Escribe sobre la mayoría de las superficies: cartón, madera, papel, plástico, metal...
- Punta amplia bloqueada - 1 a 5 mm
- Seguridad: tapa ventilada
- Hasta finales de stocks



| ref | **/** | | |
|--------|--------|-----|-----------------|
| 733547 | 12-96 | | |
| | | x4 | 3 154147 335475 |
| 733530 | 12-144 | | |
| | | x12 | 3 154147 335307 |
| 733531 | 12-144 | | |
| | | x12 | 3 154147 335314 |
| 733532 | 12-144 | | |
| | | x12 | 3 154147 335321 |



733547



733530



733531



733532



OFICINA ENMARCADO

T É C N I C A × R O B U S T O × I N N O V A D O R A

Essentials Metal Office Colours - Grapadoras de mesa

- ▶ Grapadora metálica
- ▶ 2 funciones: grapado, claveteado
- ▶ 180° de apertura para facilitar el llenado



Half Strip

- Capacidad de depósito: 100 grapas 24/6 o 140 grapas 26/6
- Profundidad de grapado: 61 mm
- Tirador de metal



NEW!



ref e/..

354300

10-60



3 154143 543003

Essentials Metal Office Colours - Perforadora 2 Agujeros

- ▶ Perforadoras metálicas
- ▶ Perforación rápida y precisa, calibración en las anillas del archivador
- ▶ Sistema optimizado de sujeción de las hojas
- ▶ Producto compuesto de plástico reciclado post-industrial



20/25 Hojas

- Regleta multiformatos
- Tapa para compuesta en un 100% de plástico reciclado post-industrial



| | | | |
|--------|------|--|--|
| ref | */** | | |
| 402400 | 6-48 | | |

3 154144 024006

Essentials Metal Office Colours - Tijeras

- ▶ Hojas y remache de acero inoxidable
- ▶ Aros ergonómicos ambidiestros
- ▶ Aros compuestos de plástico reciclado post-industrial
- ▶ Embalaje reciclable de cartón



Simétricas

- Aros compuestos de 60% de plástico reciclado post-industrial



| | | | |
|--------|--------|--|--|
| ref | */** | | |
| 468002 | 24-192 | | |

17 cm

3 154144 680028

Asimétricas

- Aros compuestos de 60% de plástico reciclado post-industrial



| | | | |
|--------|--------|--|--|
| ref | */** | | |
| 468101 | 24-192 | | |

21 cm

3 154144 681018

Minis

- ▶ **Formato pequeño:** fácil de transportar y almacenar
- ▶ **Producto compuesto de plástico reciclado post-industrial**

Vivo 26/6

- Capacidad de depósito: 41 grapas 24/6 o 58 grapas 26/6
- Profundidad de grapado: 29 mm
- Función quita-grapas
- Producto compuesto de 80% de plástico reciclado post-industrial



040400



540400

Vivo 26/6 - Pastel

- Capacidad de depósito: 41 grapas 24/6 o 58 grapas 26/6
- Profundidad de engrapado: 29 mm
- Función quita-grapas
- Producto compuesto de 80% de plástico reciclado post-industrial



404000



404091



404002

| ref | */** | | |
|--------|--------|--|------------------|
| 040400 | 24-240 | 12 12 Blister + 400 grapas Disponible excepto para Francia | 3 154 140 404000 |
| 540400 | 20-200 | 10 10 Disponible excepto para Francia | 3 154 145 404005 |

| ref | */** | | |
|--------|--------|--|------------------|
| 404000 | 24-240 | 8 8 Blister + 400 grapas Disponible excepto para Francia | 3 154 144 040006 |
| 404091 | 24-240 | 8 8 Blister + 400 grapas | 3 154 144 040914 |
| 404002 | 20-200 | 6 7 Disponible excepto para Francia | 3 154 144 040020 |

Vivo N°10

- Capacidad de depósito: 58 grapas N°10
- Profundidad de grapado: 29 mm
- Función quita-grapas
- Producto compuesto de 80% de plástico reciclado post-industrial



040300



540300

Vivo N°10 - Pastel

- Capacidad de depósito: 58 grapas N°10
- Profundidad de grapado: 29 mm
- Función quita-grapas
- Producto compuesto de 80% de plástico reciclado post-industrial



403000



403001

| ref | */** | | |
|--------|--------|--|------------------|
| 040300 | 24-240 | 12 12 Blister + 400 grapas | 3 154 140 403003 |
| 540300 | 20-320 | 10 10 Disponible excepto para Francia | 3 154 145 403008 |

| ref | */** | | |
|--------|--------|--|------------------|
| 403000 | 24-240 | 8 8 Blister + 400 grapas | 3 154 144 030007 |
| 403001 | 20-320 | 6 7 Disponible excepto para Francia | 3 154 144 030014 |

Start - Grapadora de mesa

- ▶ Grapadora metálica
- ▶ Merchandising optimizado: orientación vertical para colgar y orientación horizontal para estantería

Half Strip

- Capacidad de depósito: 100 grapas 24/6 o 140 grapas 26/6
- Profundidad de grapado: 57 mm



| ref | */** | | |
|--------|-------|---|---|
| 392710 | 10-60 | ■ |  |

Greenlogic - Grapadoras compactas

- ▶ Una gama ecológica y económica
- ▶ Producto compuesto principalmente de plástico reciclado post-industrial
- ▶ Función quita-grapas



Mini 26/6

- Capacidad de depósito: 41 grapas 24/6 o 58 grapas 26/6
- Profundidad de grapado: 28 mm
- Producto compuesto de 95% de plástico reciclado post-industrial



353010



353011

Pocket N°10



- Capacidad de depósito: 88 grapas N°10
- Profundidad de grapado: 43 mm
- Producto compuesto de 97% de plástico reciclado post-industrial





353210



353211

| ref | */** | | |
|--------|--------|---|---|
| 353010 | 20-200 |  |  |
| | | Blister + 400 grapas | 3 154 143 530102 |
| 353011 | 20-320 | ■ |  |
| | | Embalaje de cartón reciclable | 3 154 143 530119 |

| ref | */** | | |
|--------|--------|--|---|
| 353210 | 12-120 |  |  |
| | | Blister + 400 grapas | 3 154 143 532106 |
| 353211 | 20-160 | ■ |  |
| | | Embalaje de cartón reciclable | 3 154 143 532113 |

Greenlogic - Grapadoras de mesa

- ▶ Una gama ecológica y económica
- ▶ Producto compuesto de 100% de plástico reciclado post-industrial
- ▶ Envase ecodiseñado
- ▶ 2 funciones: grapado, claveteado
- ▶ Ahorra espacio: utilización vertical u horizontal



Half Strip

- Capacidad de depósito: 100 grapas 24/6 o 140 grapas 26/6
- Profundidad de grapado: 53 mm
- 160° de apertura para facilitar el llenado
- Tirador de metal
- Producto compuesto de 100% de plástico reciclado post-industrial



Full Strip

- Capacidad de depósito: 150 grapas 24/6 o 200 grapas 26/6
- Profundidad de grapado: 84 mm
- 180° de apertura para facilitar el llenado
- Tirador de metal
- Producto compuesto de 100% de plástico reciclado post-industrial



| ref | */** | | |
|--------|-------|---|-------------------------------|
| 353410 | 12-72 | ■ | Blister + 400 grapas |
| | | | |
| 353411 | 10-60 | ■ | Embalaje de cartón reciclable |
| | | | |

| ref | */** | | |
|--------|-------|---|-------------------------------|
| 353611 | 10-80 | ■ | Embalaje de cartón reciclable |
| | | | |

Essentials Desk - Grapadora de mesa

- ▶ 3 funciones: grapado, punteado, claveteado
- ▶ Base antideslizante
- ▶ 180° de apertura para facilitar el llenado
- ▶ Merchandising optimizado: orientación vertical para colgar y orientación horizontal para estantería



Half-Strip - A17

- Capacidad de depósito: 100 grapas 24/6 o 140 grapas 26/6
- Profundidad de grapado: 57 mm



| ref | */** | | |
|--------|-------|---|---------------------------------|
| 953511 | 16-96 | ■ | Disponible excepto para Francia |
| | | | |

Essentials Metal - Grapadoras compactas

- ▶ Grapadoras metálicas
- ▶ Quita-grapas integrado

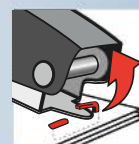

Mini 26/6 - E3524

- Capacidad de depósito: 41 grapas 24/6 o 58 grapas 26/6
- Profundidad de grapado: 24 mm



| ref | •/•• | | |
|--------|--------|---|---|
| 352411 | 20-320 | ■ |  3 154143 524118 |

Mini N°10 - E3523

- Capacidad de depósito: 58 grapas N°10
- Profundidad de grapado: 24 mm



| ref | •/•• | | |
|--------|--------|---|---|
| 352311 | 20-320 | ■ |  3 154143 523111 |

Pocket N°10 - E3526

- Capacidad de depósito: 88 grapas N°10
- Profundidad de grapado: 40 mm



| ref | •/•• | | |
|--------|--------|---|---|
| 352611 | 20-200 | ■ |  3 154143 526112 |

Essentials Metal - Grapadoras de mesa

- ▶ Grapadoras metálicas
- ▶ 2 funciones: grapado, claveteado
- ▶ 180° de apertura para facilitar el llenado
- ▶ Merchandising optimizado: orientación vertical para colgar y orientación horizontal para estantería



Half Strip - E3543

- Capacidad de depósito: 100 grapas 24/6 o 140 grapas 26/6
- Profundidad de grapado: 61 mm
- Tirador de metal



Full Strip - E3544

- Capacidad de depósito: 150 grapas 24/6 o 200 grapas 26/6
- Profundidad de grapado: 84 mm
- Tirador de metal



| | | | |
|--------|-------|---|--|
| ref | •/•• | | |
| 354311 | 10-60 | ■ | |

| | | | |
|--------|------|---|--|
| ref | •/•• | | |
| 354411 | 8-48 | ■ | |

Expositor de mostrador - Essentials

- Entregado lleno
- Material: cartón
- Las dimensiones vienen indicadas para un display montado (incluyendo cartelas)
- Características: anchura 355 mm, profundidad 185 mm, altura 270 mm
- Promoción cliente incluida (+ pegatinas in 12 idiomas)



Kit de grapado

- Contenido: 1 grapadora Half Strip, 1 perforadora de 20/25 hojas



| | | | |
|--------|------|---|--|
| ref | •/•• | | |
| 993314 | 1- | 64 piezas x12 EAN 315414 354311 9 x20 EAN 315414 352411 5 x32 EAN 315414 324605 8 (regalo consumidores) | |

| | | | |
|--------|------|---|--|
| ref | •/•• | | |
| 898014 | 1-16 | ■ | |

Essentials Metal - Pinzas grapadoras

- ▶ Grapadoras metálicas
- ▶ Quita-grapas integrado
- ▶ Orificio de enganche
- ▶ 180° de apertura para facilitar el llenado
- ▶ Merchandising optimizado: orientación vertical para colgar y orientación horizontal para estantería

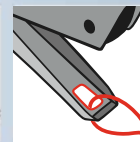
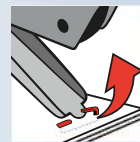

Pinza 26/6 - E4402

- Capacidad de depósito: 150 grapas 24/6 o 200 grapas 26/6
- Profundidad de grapado: 45 mm
- Tirador de metal



| ref | */** | | |
|--------|-------|---|-----------------|
| 440210 | 10-60 | ■ | 3 154144 402101 |

Pinza N°10 - E4400

- Capacidad de depósito: 200 grapas N°10
- Profundidad de grapado: 35 mm
- Tirador de metal



| ref | */** | | |
|--------|-------|---|-----------------|
| 440010 | 10-60 | ■ | 3 154144 400107 |

Pinza BB 8/4 - E4401

- Capacidad de depósito: 160 grapas BB o 8/4
- Profundidad de grapado: 35 mm
- Tirador de metal



| ref | */** | | |
|--------|-------|---|-----------------|
| 440110 | 10-60 | ■ | 3 154144 401104 |

Universal - Grapadoras compactas

- ▶ Grapadoras metálicas
- ▶ Quita-grapas integrado



Mini Metal 26/6

- Capacidad de depósito: 41 grapas 24/6 o 58 grapas 26/6
- Profundidad de grapado: 24 mm



Mini Metal N°10

- Capacidad de depósito: 58 grapas N°10
- Profundidad de grapado: 24 mm



| | | | | |
|--------|--------|----|----|----------------------|
| ref | e/.. | | | |
| 044900 | 24-240 | 12 | 12 | Blister + 400 grapas |

| | | | | |
|--------|--------|----|----|----------------------|
| ref | e/.. | | | |
| 044600 | 24-240 | 12 | 12 | Blister + 400 grapas |

Pocket N°10

- Capacidad de depósito: 88 grapas N°10
- Profundidad de grapado: 40 mm



Oficina set

- Los 4 imprescindibles para la oficina
- Contenido: 1 perforadora 10/12 hojas, 1 grapadora Pocket N°10, 1 quita-grapas, 1 caja de 1000 grapas N°10



| | | | | |
|--------|--------|----|----|----------------------|
| ref | e/.. | | | |
| 043500 | 20-120 | 10 | 10 | Blister + 400 grapas |

| | | | | |
|--------|------|--|--|--|
| ref | e/.. | | | |
| 631760 | 9-36 | | | |

Universal - Grapadoras de mesa

- ▶ Grapadoras metálicas
- ▶ 2 funciones : grapado, punteado
- ▶ 180° de apertura para facilitar el llenado

Half Strip

- Capacidad de depósito: 100 grapas 24/6 o 140 grapas 26/6
- Profundidad de grapado: 61 mm
- Tirador de metal



| ref | */** | 5 5 | | Blister + 400 grapas | | 3 154 140 392000 | |
|--------|-------|-----|--|----------------------|--|------------------|--|
| 039200 | 10-50 | | | | | | |

Half Strip - Pastel

- Capacidad de depósito: 100 grapas 24/6 o 140 grapas 26/6
- Profundidad de grapado: 61 mm
- Tirador de metal



| ref | */** | 5 5 | | Blister + 400 grapas | | 3 154 143 543010 | |
|--------|-------|-----|--|----------------------|--|------------------|--|
| 354301 | 10-50 | | | | | | |

Universal - Pinzas grapadoras

- ▶ Grapadoras metálicas
- ▶ Función quita-grapas
- ▶ Orificio de enganche
- ▶ 180° de apertura para facilitar el llenado

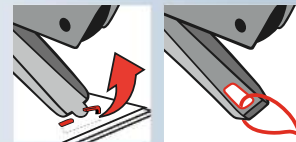

Pinza 26/6

- Capacidad de depósito: 150 grapas 24/6 o 200 grapas 26/6
- Profundidad de grapado: 48 mm
- Tirador de metal



| ref | */** | 5 5 | | Blister + 400 grapas | | 3 154 140 442002 | |
|--------|-------|-----|--|----------------------|--|------------------|--|
| 044200 | 10-60 | | | | | | |

Pince 26/6 - Pastel

- Capacidad de depósito: 150 grapas 24/6 o 200 grapas 26/6
- Profundidad de grapado: 48 mm
- Tirador de metal



| ref | */** | 5 5 | | Blister + 400 grapas | | 3 154 144 406000 | |
|--------|-------|-----|--|----------------------|--|------------------|--|
| 440600 | 10-60 | | | | | | |

Advanced Metal - Grapadoras de mesa

- ▶ Grapadoras metálicas
- ▶ Mecanismo antibloqueo de grapas
- ▶ 3 funciones: grapado, punteado, claveteado
- ▶ 180° de apertura para facilitar el llenado - Reserva para 2 barras de grapas
- ▶ Merchandising optimizado: orientación vertical para colgar y orientación horizontal para estantería

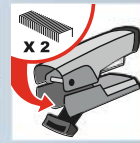

Half Strip - A3545

- Capacidad de depósito: 100 grapas 24/6 o 140 grapas 26/6
- Profundidad de grapado: 52 mm
- Tirador de metal



354510



354511

| ref | e/.. | | |
|--------|------|--|-----------------|
| 354510 | 9-54 | | 3 154143 545106 |
| 354511 | 9-54 | | 3 154143 545113 |

Half Strip Collector - A3545

- Capacidad de depósito: 100 grapas 24/6 o 140 grapas 26/6
- Profundidad de grapado: 52 mm
- Tirador de metal



354512



354513

| ref | e/.. | | |
|--------|------|--|-----------------|
| 354512 | 6-36 | | 3 154143 545120 |
| 354513 | 6-36 | | 3 154143 545137 |

Expositor de mostrador

- Entregado lleno
- Material: cartón
- Las dimensiones vienen indicadas para un display montado (incluyendo cartelas)
- Características: anchura 355 mm, profundidad 185 mm, altura 270 mm
- Promoción consumidores incluida (+ pegatinas in 12 idiomas)



| ref | */** | | |
|--------|------|---|--|
| 993315 | 1- | 32 piezas x8 EAN 315414 354511 3 x4 EAN 315414 354510 6 x4 EAN 315414 354513 7 x16 EAN 315414 324605 8 (regalo consumidores) |  3 154149 933150 |

Kit de grapado

- Contenido: 1 grapadora Half Strip, 1 perforadora 20/25 hojas



| ref | */** | | |
|--------|------|--|--|
| 898011 | 1-16 | |  3 154148 980117 |

Advanced Metal - Pinza grapadora

- ▶ Grapadora metálica
- ▶ Mecanismo antibloqueo de grapas
- ▶ Yunque de 2 funciones: grapado, punteado
- ▶ 180° de apertura para facilitar el llenado
- ▶ Merchandising optimizado: orientación vertical para colgar y orientación horizontal para estantería



Pinza 26/6 - A4474

- Capacidad de depósito: 150 grapas 24/6 o 200 grapas 26/6
- Profundidad de grapado: 45 mm
- Orificio de enganche
- Tirador de metal

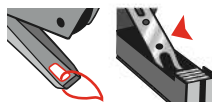

| ref | */** | | |
|--------|-------|--|--|
| 447411 | 10-60 | |  3 154144 474115 |

Ergologic - Grapadoras compactas

- ▶ Zona de apoyo blanda
- ▶ Reserva para 2 barras de grapas
- ▶ Quita-grapas plegable



Mini 26/6

- Capacidad de depósito: 41 grapas 24/6 o 58 grapas 26/6
- Profundidad de grapado: 27 mm



352110



352190



352111

| ref | */** | | |
|--------|--------|-------------------------------|------------------|
| 352110 | 16-160 | 8 4 4 Blister + 400 grapas | 3 154 143 521100 |
| 352190 | 16-160 | Blister + 400 grapas | 3 154 143 521902 |
| 352111 | 20-240 | 10 5 5 | 3 154 143 521117 |

Pocket N°10

- Capacidad de depósito: 88 grapas N°10
- Profundidad de grapado: 37 mm

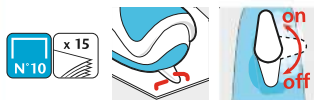

352210



352290



352211

| ref | */** | | |
|--------|--------|-------------------------------|------------------|
| 352210 | 12-120 | 6 3 3 Blister + 400 grapas | 3 154 143 522107 |
| 352290 | 12-120 | Blister + 400 grapas | 3 154 143 522909 |
| 352211 | 20-180 | 10 5 5 | 3 154 143 522114 |

Ergologic - Grapadoras de mesa

- ▶ Mecanismo antibloqueo de grapas
- ▶ Zona de apoyo blanda
- ▶ Reserva para 2 barras de grapas



Half Strip

- Capacidad de depósito: 100 grapas 24/6 o 130 grapas 26/6
- Profundidad de grapado: 60 mm
- Tirador de metal



352510



352511



352513

| ref | */** | | |
|--------|-------|----------------------|------------------|
| 352510 | 8-48 | 5 3 | 3 154 143 525108 |
| | | Blister + 400 grapas | |
| 352511 | 10-60 | | 3 154 143 525115 |
| 352513 | 10-60 | 6 4 | 3 154 143 525139 |

Easy - Grapadoras de mesa

- ▶ Más eficacia con menos esfuerzo
- ▶ No hay riesgo de proyección de las grapas
- ▶ Recarga fácil de las grapas por la parte delantera (front loading)

- 70 %
Effort



Half Strip

- Capacidad de depósito: 100 grapas 24/6 o 130 grapas 26/6
- Profundidad de grapado: 67 mm



| ref | */** | | |
|--------|------|--|------------------|
| 455211 | 8-48 | | 3 154 144 552110 |

Expert - Grapadoras de mesa

- ▶ Grapadoras metálicas
- ▶ Ahorre el 30% de espacio de organización gracias al sistema de grapado plano
- ▶ Mecanismo antibloqueo de grapas
- ▶ Recarga fácil de las grapas por la parte delantera
- ▶ Visualización del stock de grapas



Half Strip

- Capacidad de depósito: 100 grapas 24/6-8 o 150 grapas 26/6-8
- Profundidad de grapado: 65 mm



Expert - Pinzas grapadoras

- ▶ Grapadoras metálicas
- ▶ Diseño ergonómico y mecánico reforzado para uso prolongado sin cansancio
- ▶ Recarga fácil de las grapas por la parte delantera
- ▶ Visualización del stock de grapas
- ▶ Quita-grapas integrado - Orificio de enganche



Pinza XL

- Capacidad de depósito: 156 grapas 24/6-8 o 210 grapas 26/6-8
- Profundidad de grapado: 60 mm
- Mecanismo antibloqueo de grapas



Pinza N°10

- Capacidad de depósito: 210 grapas N°10
- Profundidad de grapado: 60 mm



| ref | */** | | |
|--------|-------|--|--|
| 450010 | 10-60 | | |

3 154144 500104

Pinza Uni 6/4

- Capacidad de depósito: 210 grapas 6/4
- Profundidad de grapado: 60 mm



| ref | */** | | |
|--------|-------|--|--|
| 442110 | 10-60 | | |

3 154144 421102

Expert - Grapadora gran capacidad

- ▶ Grapadora metálica
- ▶ Mecanismo antibloqueo de grapas
- ▶ Zona de apoyo blanda
- ▶ Ajuste de la profundidad de grapado
- ▶ Zapatillas antideslizantes



Grapadora - HD90

- Capacidad de depósito: 110 grapas 24/6-8 y 23/6 o 108 grapas 23/8-10 o 105 grapas 24/10 y 23/12-13
- Profundidad de grapado: 55 mm (profundidad regulable)
- Tirador de metal

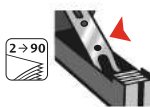

| ref | */** | | |
|--------|------|--|--|
| 544500 | 1-14 | | |

3 154145 445008

Grapas

- ▶ **Calidad superior**
- ▶ **Recomendadas para conseguir resultados óptimos**
- ▶ **Código de colores:** sobre las grapadoras y los envases: ¡Encuentre con facilidad las grapas compatibles con su grapadora!



Estándares

Caja colgable

| ref | e/.. | | |
|--------|--------|--------------|--|
| 324104 | 36-252 | N°10 x 2 000 | |
| 324106 | 24-120 | N°10 x 5 000 | |
| 324402 | 32-160 | 24/6 x 2 000 | |

| ref | e/.. | | |
|--------|--------|--------------|--|
| 324401 | 24-72 | 24/6 x 5 000 | |
| 324604 | 32-192 | 26/6 x 2 000 | |
| 324606 | 24-72 | 26/6 x 5 000 | |



Caja colgable - Grapas Colors

| ref | e/.. | | |
|--------|--------|--|--|
| 324806 | 48-528 | 26/6 x 800 Colors Hasta finales de stocks | |



Caja

| ref | e/.. | | |
|--------|--------|--------------|--|
| 324105 | 36-540 | N°10 x 1 000 | |
| 324405 | 36-288 | 24/6 x 1 000 | |
| 324605 | 36-396 | 26/6 x 1 000 | |



Normales

Caja colgable

| ref | e/.. | | |
|--------|--------|-------------------------------|--|
| 325202 | 10-100 | BB 8/4 acero cobre x 5 000 | |
| 324502 | 10-60 | 26/8 x 5 000 | |



Modelos gran capacidad

Caja

| ref | e/.. | | |
|--------|--------|---------------|--|
| 323705 | 10-100 | 23/17 x 1 000 | |
| 323805 | 8-72 | 23/20 x 1 000 | |



Específicas

Caja colgable

| ref | */** | | |
|--------|--------|----------------|---|
| 325305 | 10-320 | 21/4 x 1 000 |  |
| 326402 | 10-60 | 66/8 x 5 000 |  |
| 326602 | 10-80 | 19 1/4 x 5 000 |  |



Caja

| ref | */** | | |
|--------|--------|--|---|
| 326205 | 20-200 | J/8 de acero cobre x 1 000 Hasta finales de stocks |  |



Quita-grapas

Start

- Zona de empuñadura antirresbaladiza para uso preciso

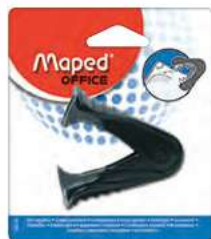

370110



370111

| ref | */** | | |
|--------|--------|---|---|
| 370110 | 20-200 | ■ |  |
| 370111 | 20-200 | ■ |  |

Oficina

- Botón de bloqueo para mantenerlo cerrado



037100



537100

| ref | */** | | |
|--------|--------|------------------------------|---|
| 037100 | 20-240 | ■ |  |
| 537100 | 20-200 | ■ Hasta finales de stocks |  |

Perforadoras compactas

► Fáciles de transportar y almacenar

Punchito

- Guía que se posiciona sobre los arros de los archivadores
- Botón para mantenerlo cerrado en el estuche de lápices



033100



533100

| ref | */** | | |
|--------|--------|--|---|
| 033100 | 20-160 | | 7 |
| 533100 | 18-324 | | 6 |



Greenlogic - Perforadora plana



- La primera perforadora que se guarda y transporta en los aros del archivador
- Producto compuesto en un 52% de plástico reciclado post-industrial
- Envase eco-diseñado
- Depósito integrado
- Sistema de sujeción de las hojas

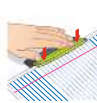
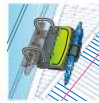

| ref | */** | | |
|--------|--------|--|--|
| 339410 | 10-120 | | |



Essentials Green - 2 Agujeros

- Perforadoras ecológicas y económicas
- Innovación: 3D efecto texturizado y tacto suave
- Perforación rápida y precisa, calibración de los aros del archivador
- Regleta multiformatos
- Merchandising optimizado: orientación vertical para colgar y orientación horizontal para estantería

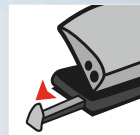

10/12 Hojas

- Producto compuesto en un 25% de plástico reciclado post-industrial*
- Envase eco-diseñado
- Reserva de restos de papel

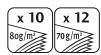

| ref | */** | | |
|--------|------|--|--|
| 451211 | 6-96 | | |

*excepto punzones y matriz



20/25 Hojas

- Producto compuesto en un 21% de plástico reciclado post-industrial*
- Envase eco-diseñado
- Reserva de restos de papel



| ref | */** | | |
|--------|------|--|--|
| 452511 | 6-96 | | |

*excepto punzones y matriz



OFICINA ENMARCADO

Essentials Metal - 2 Agujeros

- ▶ Perforadoras metálicas
- ▶ Perforación rápida y precisa, calibración en los aros del archivador
- ▶ Sistema optimizado de sujeción de las hojas
- ▶ Merchandising optimizado: orientación vertical para colgar y orientación horizontal para estantería

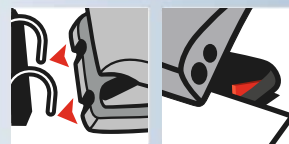

6/8 Hojas - E4522

- Tapa para vaciar restos de confetis compuesto de 100% de plástico reciclado post-industrial
- Embalaje de cartón reciclable

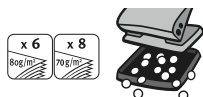

| ref | */** | | |
|--------|------|---|-----------------|
| 452211 | 6-96 | ■ | 3 154144 522113 |

10/12 Hojas - E4011 - E4013

- Regleta multiformatos
- Tapa para vaciar restos de confetis compuesto de 100% de plástico reciclado post-industrial
- Embalaje de cartón reciclable



| ref | */** | | |
|--------|------|---|--|
| 401111 | 8-64 | ■ | E4011 distancia entre aros 80 mm 3 154144 011112 |
| 401311 | 8-64 | ■ | E4013 distancia entre aros 70 mm Hasta finales de stocks 3 154144 013116 |

20/25 Hojas - E4024 - E4023

- Regleta multiformatos
- Tapa para vaciar restos de confetis compuesto de 100% de plástico reciclado post-industrial
- Embalaje de cartón reciclable



| ref | */** | | |
|--------|------|---|--|
| 402411 | 6-48 | ■ | E4024 distancia entre aros 80 mm 3 154144 024112 |
| 402311 | 6-48 | ■ | E4023 distancia entre aros 70 mm Hasta finales de stocks 3 154144 023115 |

30/35 Hojas - E4034

- Regleta multiformatos
- Botón de bloqueo
- Reserva de restos de papel de apertura fácil



| ref | */** | | |
|--------|------|---|-----------------|
| 403411 | 1-24 | ■ | 3 154144 034111 |

40/45 Hojas - E4044

- Regleta multiformatos
- Botón de bloqueo
- Reserva de restos de papel de apertura fácil



| | | | |
|--------|------|---|-----------------|
| ref | •/•• | | |
| 404411 | 1-18 | ■ | 3 154144 044110 |

60/70 Hojas - E4064

- Regleta multiformatos
- Botón de bloqueo
- Reserva de restos de papel de apertura fácil



| | | | |
|--------|------|---|-----------------|
| ref | •/•• | | |
| 406411 | 1-9 | ■ | 3 154144 064118 |

Essentials Metal - 4 Agujeros

- ▶ Perforadora metálica
- ▶ Sistema optimizado de sujeción de las hojas
- ▶ Compartimento para confetis de apertura fácil
- ▶ Merchandising optimizado: orientación vertical para colgar y orientación horizontal para estantería



10/12 Hojas - E4001



| | | | |
|--------|------|---|-----------------|
| ref | •/•• | | |
| 400111 | 1-24 | ■ | 3 154144 001113 |

Universal - 2 Agujeros

- ▶ Perforadoras metálicas
- ▶ Perforación rápida y precisa, calibración en los aros del archivador
- ▶ Sistema optimizado de sujeción de las hojas
- ▶ Tapa para vaciar los confetis compuesto de plástico reciclado post-industrial

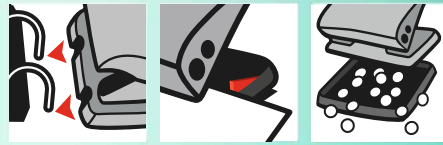

6/8 Hojas

- Tapa para vaciar los confetis compuesto de 100% de plástico reciclado post-industrial



| ref | */** | | | 3 154 140 452001 |
|--------|-------|---|---|------------------|
| 045200 | 12-72 | 6 | 6 | |

10/12 Hojas

- Regleta multiformatos
- Tapa para vaciar los confetis compuesto de 100% de plástico reciclado post-industrial



| ref | */** | | | 3 154 140 610005 |
|--------|-------|---|---|------------------|
| 061000 | 10-60 | 5 | 5 | |

20/25 Hojas

- Regleta multiformatos
- Tapa para vaciar los confetis compuesto de 100% de plástico reciclado post-industrial



| ref | */** | | | 3 154 140 620004 |
|--------|------|---|---|------------------|
| 062000 | 8-32 | 4 | 4 | |

Universal - 4 Agujeros

- ▶ Perforadora metálica
- ▶ Compartimento para confetis de apertura fácil
- ▶ Sistema de sujeción optimizada de las hojas
- ▶ Merchandising optimizado: orientación vertical para colgar y orientación horizontal para estantería



10/12 Hojas



| ref | o/.. | | |
|--------|------|--|--|
| 400112 | 1-24 | | |



Ergologic - 2 Agujeros

- ▶ Perforación rápida y precisa, calibración en los aros de la carpeta
- ▶ Vaciado fácil de los restos de papel por delante
- ▶ Zona de apoyo blanda



15/20 Hojas

- Forma adaptada para un uso a mano alzada
- Regleta multiformatos: A4, US, A5, F3 x 8, A6, 3 x 8



| ref | o/.. | | |
|--------|-------|--|--|
| 421510 | 10-40 | | |



Advanced Metal - 2 Agujeros

- ▶ Perforadoras metálicas
- ▶ Perforación rápida y precisa, calibración en los aros del archivador
- ▶ Regleta ultralegible
- ▶ Vaciado fácil de los restos de papel por delante
- ▶ Merchandising optimizado: orientación vertical para colgar y orientación horizontal para estantería

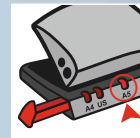

20/25 Hojas - A6203



620310



620311

| ref | •/•• | | |
|--------|------|--|--|
| 620310 | 6-48 | | |
| 620311 | 6-48 | | |

20/25 Hojas - Collector - A6203

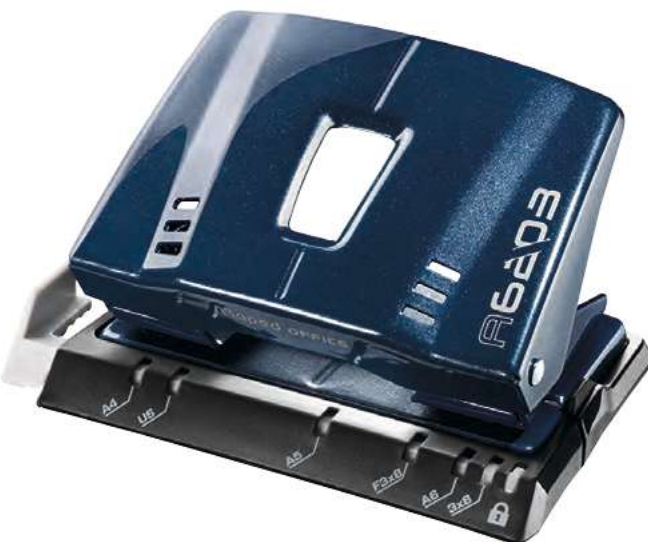

| ref | •/•• | | |
|--------|------|--|--|
| 620312 | 6-48 | | |

30/35 Hojas - A6303

- Mecanismo antibloqueo del papel
- Botón de cierre semiautomático



630310



630311

| ref | •/•• | | |
|--------|------|--|-----------------|
| 630310 | 1-24 | | 3 154146 303109 |
| 630311 | 1-24 | | 3 154146 303116 |

Advanced Metal - 4 Agujeros

- ▶ Perforadoras metálicas
- ▶ Mecanismo antibloqueo del papel
- ▶ Regleta ultralegible
- ▶ Perforación rápida y precisa, calibración en los aros del archivador
- ▶ Merchandising optimizado: orientación vertical para colgar y orientación horizontal para estantería

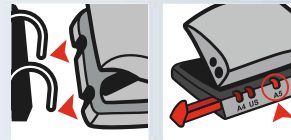

25/30 Hojas - A6225

- Sistema de sujeción optimizada de las hojas
- Vaciado fácil de los restos de papel
- Zapatas antideslizantes



| ref | •/•• | | |
|--------|------|--|-----------------|
| 622511 | 1-10 | | 3 154146 225111 |

Easy - 2 Agujeros

- ▶ Más eficacia con menos esfuerzo
- ▶ Mecanismo antibloqueo del papel
- ▶ Centrado sencillo y preciso de las hojas: sistema de color + esquemas de perforación

- 50 %
Effort



10
GARANTIE
ANNUALE

35/40 Hojas

- Depósito de confetis de apertura fácil
- Empuñadura rotatoria ergonómica, materiales suaves

x 35
80g/m²

x 40
70g/m²



ref

*/**

653510

1-8



3 154 146 535104

65/70 Hojas

- Depósito de confetis de apertura fácil
- Empuñadura rotatoria ergonómica, materiales suaves

x 65
80g/m²

x 70
70g/m²



ref

*/**

656510

1-8



3 154 146 565101

Expert - 2 Agujeros

- ▶ Perforadora de gran capacidad

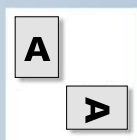

5
GARANTIE
ANNUALE

HD150

- Comodidad de uso: empuñadura rotativa
- Punzones garantizados para 20 000 perforaciones
- Se entrega con 8 discos de recambio
- Manual de instrucciones
- Compartimento para piezas de recambio

x 150
80g/m²

x 180
70g/m²



ref

*/**

565000

1-3



3 154 145 650006

Essentials Green

- ▶ Hojas y remache de acero inoxidable
- ▶ Aros ergonómicos 2D ambidiestros
- ▶ Aros compuestos de plástico reciclado post-industrial
- ▶ Embalaje de cartón reciclable



Simétricas - E4680

- Aros compuestos de 60% de plástico reciclado post-industrial



468010



468011



Asimétricas - E4681

- Aros compuestos de 60% de plástico reciclado post-industrial



468110



468111



| ref | e/.. | | |
|--------|--------|--|------------------|
| 468010 | 24-192 | | 17 cm |
| | | | 3 154 144 680103 |
| 468011 | 24-192 | | 17 cm |
| | | | 3 154 144 680110 |

| ref | e/.. | | |
|--------|--------|--|------------------|
| 468110 | 24-192 | | 21 cm |
| | | | 3 154 144 681100 |
| 468111 | 24-192 | | 21 cm |
| | | | 3 154 144 681117 |

Essentials Soft

- ▶ Hojas y remache de acero inoxidable
- ▶ Aros ergonómicos 2D
- ▶ Aros de dos materiales ambidiestros: revestimiento soft para un mayor confort
- ▶ Embalaje de cartón reciclable



Simétricas - E4682



Asimétricas - E4683



| ref | e/.. | | |
|--------|--------|--|------------------|
| 468210 | 24-192 | | 17 cm |
| | | | 3 154 144 682107 |

| ref | e/.. | | |
|--------|--------|--|------------------|
| 468310 | 24-192 | | 21 cm |
| | | | 3 154 144 683104 |

Advanced Wood

- ▶ Hojas y remache de acero inoxidable
- ▶ Comodidad y precisión para cada tipo de prensión o tamaño de la mano
- ▶ Aros ergonómicos 3D
- ▶ Aros compuestos de fibra de madera
- ▶ Embalaje de cartón reciclable



Simétricas - A4961

- Aros compuestos de 50% de fibra de madera



| ref | */** | | |
|--------|--------|--|-------|
| 496111 | 24-192 | | 17 cm |



3 154144 961110

Asimétricas - Zurdos

- Aros compuestos de 50% de fibra de madera
- Tijeras de calidad superior
- Lamas de acero inoxidable con alto contenido de carbono: mayor durabilidad



| ref | */** | | |
|--------|-------|--|-------|
| 686600 | 6-120 | | 21 cm |

Asimétricas - A4981 - A4991

- Aros compuestos de 50% de fibra de madera



498111



499111



688102

| ref | */** | | |
|--------|--------|--|---|
| 498111 | 24-144 | | 18 cm |
| 499111 | 24-144 | | 21 cm |
| 688102 | 6-48 | | 25 cm Tijeras de calidad superior 10 años de garantía |



3 154144 981118



3 154144 991117



3 154146 881027



Advanced Green

- ▶ Hojas y remache de acero inoxidable
- ▶ Comodidad y precisión para cada tipo de presión o tamaño de la mano
- ▶ Aros ergonómicos 3D
- ▶ Aros compuestos de plástico reciclado post-industrial
- ▶ Embalaje de cartón reciclable



Simétricas - A4961

- Aros compuestos de 60% de plástico reciclado post-industrial



Asimétricas - A4981 - A4991

- Anillas compuestas de 60% de plástico reciclado post-industrial



498110



499110



| ref | e/.. | |
|--------|--------|-------|
| 496110 | 24-192 | 17 cm |



3 154144 961103

| ref | e/.. | |
|--------|--------|-------|
| 498110 | 24-144 | 18 cm |
| 499110 | 24-144 | 21 cm |



3 154144 981101



3 154144 991100

Advanced Gel

- ▶ Hojas y remache de acero inoxidable
- ▶ Aros ergonómicos de dos materiales: nuevo material innovador "soft gel"
- ▶ Comodidad y precisión para cada tipo de presión o tamaño de la mano
- ▶ Cuchillas moldeadas
- ▶ Embalaje de cartón reciclable



Simétricas - A4962

- Ambidiestros



Asimétricas - A4992

- Aros ergonómicos 3D



| ref | e/.. | |
|--------|--------|-------|
| 496210 | 24-192 | 17 cm |



3 154144 962100

| ref | e/.. | |
|--------|--------|-------|
| 499210 | 24-144 | 21 cm |



3 154144 992107

HAY QUE
TRABAJAR

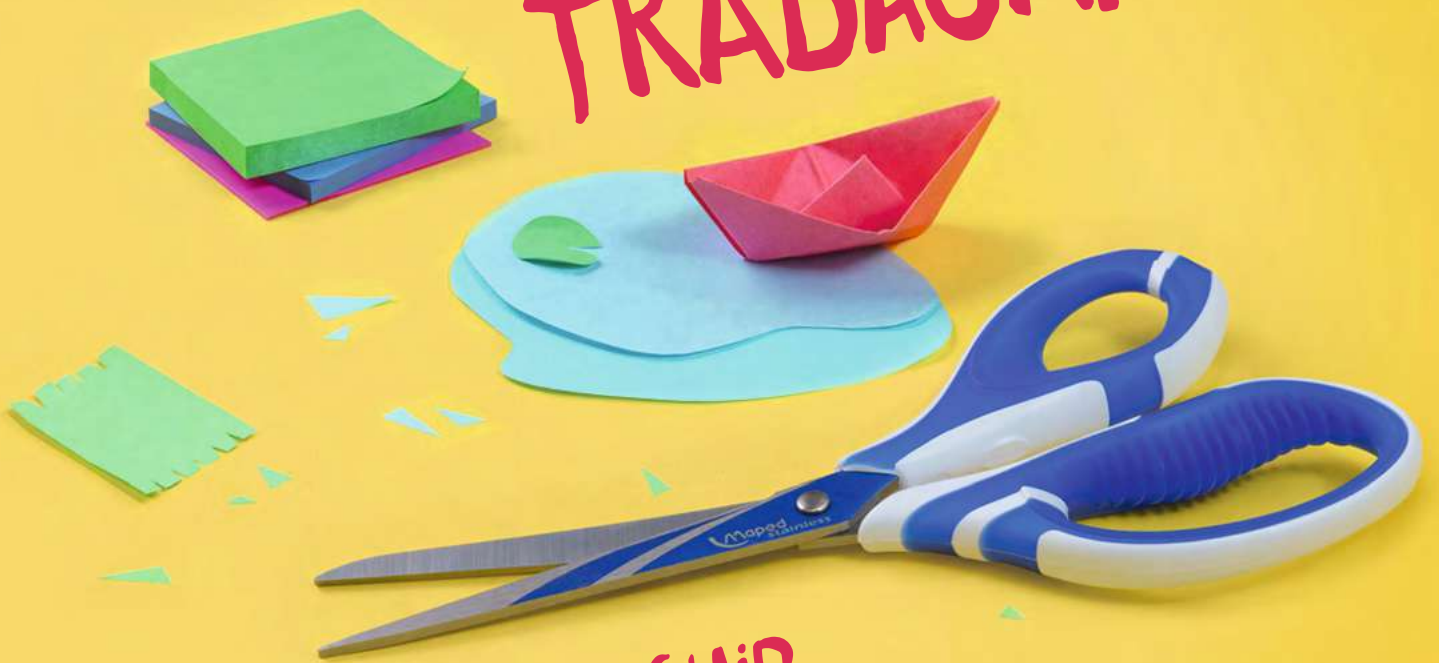

PARA CONSEGUIR
NUESTROS SUEÑOS

Zenoa Fit

- ▶ Comodidad, precisión y diseño
- ▶ Relieves soft “ Comodidad Especial ”
- ▶ Lamas de acero inoxidable decoradas
- ▶ Embalaje de cartón reciclable



Simétricas

- Ambidiestros



596110



596190

| ref | e / o | | | |
|--------|--------|-------|---|---|
| 596110 | 12-144 | | 6 | 6 |
| | | 17 cm | | |
| 596190 | 12-144 | | | |
| | | 17 cm | | |

| | |
|--|------------------|
| | 3 154 145 961102 |
| | 3 154 145 961904 |

Asimétricas

- Aros ergonómicos 3D



597110



599190



599110

| ref | e / o | | | |
|--------|--------|-------|---|---|
| 597110 | 12-144 | | 6 | 6 |
| | | 18 cm | | |
| 599190 | 12-144 | | | |
| | | 21 cm | | |
| 599110 | 12-144 | | 6 | 6 |
| | | 21 cm | | |

| | |
|--|------------------|
| | 3 154 145 971101 |
| | 3 154 145 991901 |
| | 3 154 145 991109 |

Expert

- ▶ Tijeras de calidad superior
- ▶ Lamas de acero inoxidable con alto contenido de carbono: mayor durabilidad
- ▶ Doble afilado de las lamas
- ▶ Aros ergonómicos 3D
- ▶ Embalaje de cartón reciclable



Asimétricas - Zurdos

- Auténticas tijeras para zurdos: con cuchillas invertidas
- Hasta finales de stocks



| ref | */** | | |
|--------|-------|---|---|
| 068650 | 6-120 |  | 21 cm |
| | | |  |
| | | | 3 154 140 686505 |

Asimétricas

- Hasta finales de stocks



| ref | */** | | |
|--------|------|--|---|
| 068800 | 6-48 |  | 25 cm |
| | | |  |
| | | | 3 154 140 688004 |

Ultimate

- ▶ Una gama de tijeras de ergonomía inigualable
- ▶ Lamas de acero inoxidable con alto contenido en carbono: mayor durabilidad
- ▶ Embalaje de cartón reciclable



Simétricas Precisión

- Precisión: cuchillas puntiagudas
- Estabilidad: reposadedos trasero



| ref | */** | | |
|--------|--------|---|---|
| 690210 | 12-144 |  | 13 cm |
| | | |  |
| | | | 3 154 146 902104 |



Simétricas

- Lamas con grabados decorados
- Aros doble-soft ambidiestros: innovación patentada



| ref | */** | | |
|--------|--------|--|-------|
| 692110 | 12-144 | | 17 cm |



Asimétricas

- Lamas con motivos grabados
- Aros doble-soft ambidiestros: innovación patentada



695510

697710

| ref | */** | | |
|--------|--------|--|-------|
| 695510 | 12-144 | | 18 cm |
| 697710 | 12-144 | | 21 cm |



Titanium

- ▶ Una gama de tijeras de alto rendimiento
- ▶ Lamas ultra-resistentes
- ▶ Recubrimiento de titanio para una resistencia al desgaste inigualable
- ▶ Aros ergonómicos 3D
- ▶ Embalaje de cartón reciclable



Simétricas



| ref | */** | | |
|--------|--------|--|-------|
| 684110 | 12-144 | | 17 cm |



Asimétricas



| ref | */** | | |
|--------|--------|--|-------|
| 686110 | 12-144 | | 21 cm |



Diamond

- ▶ "Un concentrado de innovaciones"
- ▶ La mejor calidad de corte, el mejor empuñadura
- ▶ Resistencia y durabilidad sin igual: tecnología exclusiva "Diamond"
- ▶ Aros doble-soft ambidiestros: innovación patentada
- ▶ Embalaje de cartón reciclable



Simétricas



| ref | */** | | |
|--------|--------|-------|---|
| 692310 | 12-144 | 17 cm |  |

Asimétricas



| ref | */** | | |
|--------|--------|-------|---|
| 697910 | 12-144 | 21 cm |  |

Start

- ▶ Bloqueo manual de la cuchilla
- ▶ Corta-cuchillas integrado



Diestro

| ref | */** | | |
|--------|--------|--------------------------------|---|
| 092211 | 20-200 | 9 mm |  |
| 092213 | 20-200 | 9 mm Blister + 10 cuchillas |  |
| 018211 | 20-200 | 18 mm |  |



092211



092213



018211

Universal plástico

- ▶ Bloqueo manual de la cuchilla
- ▶ Corta-cuchillas integrado



Diestro



092310



018310



092311



018311

| ref | */** | | |
|--------|--------|--|------------------|
| 092310 | 20-200 | 6 7 7 9 mm | 3 154 140 923105 |
| 018310 | 20-200 | 6 7 7 18 mm | 3 154 140 183103 |
| 092311 | 12-216 | 4 4 4 9 mm x12 EAN 315414 092311 2 Disponible excepto para Francia | |
| 018311 | 12-216 | 4 4 4 18 mm x12 EAN 315414 018311 0 Disponible excepto para Francia | |

Zenoa Sensitiv

- ▶ Confort soft
- ▶ Bloqueo automático de la cuchilla
- ▶ Corta-cuchillas integrado



Diestro



086010



086110

| ref | */** | | |
|--------|--------|------------|------------------|
| 086010 | 20-200 | 1 9 mm | 3 154 140 860103 |
| 086110 | 20-200 | 1 18 mm | 3 154 140 861100 |

Ultimate

- ▶ Una amplia combinación de confort, seguridad y diseño
- ▶ Bloqueo automático de la cuchilla
- ▶ Confort doble soft: índice + palma
- ▶ Corta-cuchillas integrado

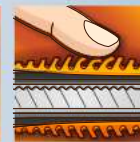

Diestro



086410



086610



| ref | */** | | |
|--------|--------|--|--------------------|
| 086410 | 20-160 | | 3 154 140 864 10 1 |
| 086610 | 20-160 | | 3 154 140 866 10 5 |

Zurdos

- ¡El 1^{er} cúter para zurdos!



086510



086710



| ref | */** | | |
|--------|-------|----------|--------------------|
| 086510 | 12-96 | - Zurdos | 3 154 140 865 10 8 |
| 086710 | 12-96 | - Zurdos | 3 154 140 867 10 2 |

Expert

- ▶ Seguridad: cuchilla trapezoidales autoretráctil
- ▶ Solidez: cúter 100% metálico



Accesorios

- ▶ Compatibles con todos nuestros cúteres estándares

Metal auto retráctil

- 2 posiciones para un empuñadura en la mano más cómoda
- Reserva por cuchillas integrada
- Cuchillas para Cúter Expert y cúter acodado



085110



085910



| ref | */** | | |
|--------|--------|-----------------------------|--------------------|
| 085110 | 8-80 | | 3 154 140 85 110 1 |
| 085910 | 24-288 | Cuchillas trapezoidales x10 | 3 154 140 85 910 7 |

Cuchillas x10



640717



640721



| ref | */** | | |
|--------|--------|-------|--------------------|
| 640717 | 25-300 | 9 mm | 3 154 146 40 717 3 |
| 640721 | 25-250 | 18 mm | 3 154 146 40 721 0 |

Universal

- ▶ Precisión y comodidad de corte
- ▶ Mesa de acero



Cizalla

- Empuñadura ergonómica
- Cuchilla no afilada
- Manual de instrucciones

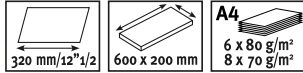

| ref | */** | | |
|--------|------|--|------------------|
| 888610 | 1-3 | Formato A4 Peso: 1,8 kg Trazados: A6, A5, A4 Carta US 8,5 x 11, Foto 9 x 13 | 3 154 148 886105 |

Guillotinas - Cortes rectos

- ▶ Base antideslizantes - Con 2 hojas de corte

Compact Cut A4

- Práctico: fácil de utilizar y de guardar
- Regleta en cm y pulgadas



089093



089301

Precise Cut A4

- Seguridad: cuchilla auto-retráctil
- Facilidad de calado y sujeción del papel
- Capacidad máxima de corte: 5 hojas x 80 g
- Regleta en cm y pulgadas



894910



894110

| ref | */** | | |
|--------|--------|---------------------|------------------|
| 089301 | 6-48 | Color opaco | 3 154 140 893019 |
| 089093 | 12-240 | Cuchillas rectas x2 | 3 154 140 890933 |

| ref | */** | | |
|--------|--------|---------------------|------------------|
| 894110 | 6-36 | Color opaco | 3 154 148 941101 |
| 894910 | 12-240 | Cuchillas rectas x2 | 3 154 148 949107 |

Ergologic

► La imprescindible del mercado

Redonda 50 mm

- Aumento: x3
- Cristal óptico antideformación
- Comodidad: mango ergonómico suave para una empuñadura confortable

x3

| ref | */** | | |
|--------|--------|---|---|
| 039100 | 12-120 | ■ |  |



Redonda 75 mm

- Aumento: x3
- Cristal óptico antideformación
- Comodidad: mango ergonómico suave para una empuñadura confortable

x3

| ref | */** | | |
|--------|-------|---|---|
| 039300 | 12-84 | ■ |  |
| 539300 | 10-90 | ■ |  |



039300

539300

Rectangular luminosa

- Aumento: lente x2, distancia focal x6
- Dimensiones lente: 8,9 cm x 5,7 cm
- Máxima visibilidad: formato rectangular sin borde
- Funciona con 2 pilas LR03 (no incluidas)
- Iluminación precisa con 2 leds

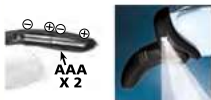

| ref | */** | | |
|--------|------|---|---|
| 395211 | 8-32 | ■ |  |

Especiales

Lupa de bolsillo

- Aumento: x3
- Tamaños lente: 4,8 cm x 4,3 cm
- Protección óptima contra polvo e impactos gracias a su estuche protector
- Hasta finales de stocks



| ref | •/•• | |
|--------|--------|---|
| 392510 | 12-180 |  |



Lupa regleta

- Formato de regleta para un buen empuñadura y un uso prolongado, sin esfuerzos
- Localizador visual, para facilitar la lectura
- Aumento: regleta x 1,5, lentes x 3
- Acompañada de un estuche de protección
- Anchura: 25 cm



| ref | •/•• | |
|--------|------|---|
| 395110 | 6-48 |  |



Expositor de mostrador - Lupas

- Base de espuma: muy estable
- Incluye 15 lupas:
- 5 lupas ergologic 50 mm
- 5 lupas ergologic 75mm
- 3 lupas rectangulares luminosas (pilas no incluidas)
- 2 lupas pocket
- Características: anchura 28 cm, altura 28 cm, profundidad 25.5 cm
- Hasta finales de stocks



| ref | •/•• | |
|--------|------|---|
| 993010 | 1-6 |  |

Essentials Green - Complementos de oficina

- ▶ Una gama ecológica de accesorios de oficina
- ▶ Producto compuesto de plástico reciclado post-industrial
- ▶ Embalaje de cartón reciclable



Distribuidor de cinta adhesiva - Fix Max **ETHIC**

- Puede instalarse sobre cualquier superficie (salvo papel) para utilizarlo con una sola mano
- Incluye cinta adhesiva 19 mm x 25 m
- Producto compuesto de 53% de plástico reciclado post-industrial



Distribuidor de clips estándar

- Base antideslizante
- Incluye 100 clips
- Extremo imantado
- Producto compuesto de 33% de plástico reciclado post-industrial



Porta-accesorios - Compact Office **ETHIC**

- Formato compacto para una organización optimizada
- 6 compartimentos
- Producto compuesto de 55% de plástico reciclado

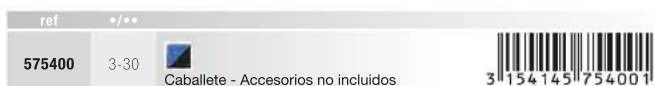

Porta-accesorios - Maxi Office **ETHIC**

- 8 compartimentos
- Producto compuesto de 50% de plástico reciclado



Expert - Distribuidor de cinta adhesiva

- ▶ Para un uso intensivo y profesional
- ▶ Base lastrada y cuñas antideslizantes para utilizar con una sola mano
- ▶ No incluida cinta adhesiva
- ▶ Producto compuesto de plástico reciclado post-industrial
- ▶ Embalaje de cartón reciclable



Compact Pro

- Distribuidor de cinta compacta para ahorrar espacio
- Para todos los formatos de rollos (33 m x 12 o 19 mm, 66 m x 12 o 19 mm)
- Zócalo lastrado 1kg
- Producto compuesto de 75% de plástico reciclado post-industrial



| | | | |
|--------|------|--|---|
| ref | •/•• | | |
| 750001 | 1-12 | |  |

Oficina

- ▶ Lo imprescindible

Almohadilla de tinta



Tinta negra

| | | | |
|--------|--------|--|---|
| ref | •/•• | | |
| 630700 | 20-100 | |  |

Fechador

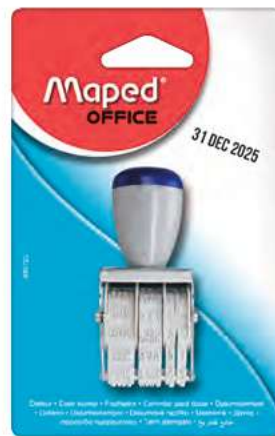

| | | | |
|--------|--------|--|---|
| ref | •/•• | | |
| 630725 | 20-120 | |  |

Pincha notas



Base y varilla metálicas

| | | | |
|--------|--------|--|---|
| ref | •/•• | | |
| 537300 | 10-120 | |  |

Abrecartas



Mango ergonómico
Longitud: 17 cm

| | | | |
|--------|--------|--|---|
| ref | •/•• | | |
| 037400 | 20-120 | |  |

Caja abre-fácil

- ▶ **Apertura y cierre práctico**
- ▶ **Sistema de puesta en gancho facilitado:** caja de cartón SPCB con orificio precortado para puesta en gancho con más facilidad
- ▶ **Cantidad SPCB:** corresponde al llenado de un gancho de 30 cm



Clips

25 mm
Acero



ref

*/**

320011

12-192



3 154 143 200 111

Clips color

25 mm
Acero lacado - Colores surtidos

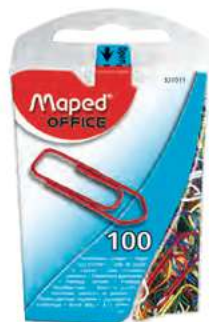

ref

*/**

321011

12-192



3 154 143 210 110

Clips gigantes

50 mm
Acero plastificado - Colores surtidos



ref

*/**

342011

12-192



3 154 143 420 113

Encuadernadores

17 mm
Latón

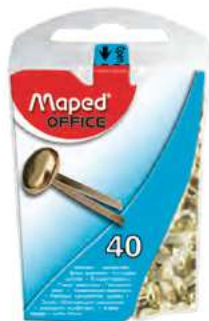

ref

*/**

330011

12-192



3 154 143 300 118

Chinchetas encobradas

10 mm



ref

*/**

311011

12-192



3 154 143 110 113

Chinchetas color

10 mm
Acero plastificado - Colores surtidos



ref

*/**

310011

12-192



3 154 143 100 114

Chinchetas memo

10 mm
Colores surtidos



ref

*/**

345011

12-192



3 154 143 450 110

Alfileres de señalización

5 mm
Colores surtidos



ref

*/**

346011

12-192



3 154 143 460 119

Pinzas clip

15 mm
Colores surtidos



ref

*/**

361211

12-192



3 154 143 612 112

Clips

► Caja de cartón

Alta resistencia x100



032020

032060

Medio x100



322320

322420

| ref | •/•• | | |
|--------|--------|------------------------------------|--|
| 032020 | 10-180 | 25 mm Acero de calidad superior | |
| 032060 | 10-70 | 32 mm Acero de calidad superior | |

| ref | •/•• | | |
|--------|--------|-------|--|
| 322320 | 10-120 | 32 mm | |
| 322420 | 10-60 | 45 mm | |

Alta resistencia x1 000



| ref | •/•• | | |
|--------|------|-----------------------------------|--|
| 032061 | 1-10 | 32 mm - Acero de calidad superior | |

Medio x1 000



322320

322420

| ref | •/•• | | |
|--------|------|-------|--|
| 322330 | 1-11 | 30 mm | |
| 322330 | 1-11 | 32 mm | |

Clips x100

► Caja de cartón

Ondulados



039630

039640

| ref | •/•• | | |
|--------|------|--------------------------|--|
| 039630 | 1-60 | 50 mm Acero niquelado | |
| 039640 | 1-20 | 77 mm Acero niquelado | |

Pinzas

Doble clip - Color



036102

036100

| ref | */** | | |
|--------|--------|--|---------------------------------|
| 036102 | 15-150 | | x10 - 19 mm Colores surtidos |
| 036100 | 15-150 | | x4 - 32 mm Colores surtidos |

Doble clip - Negras



036151

036161

036171

| ref | */** | | |
|--------|------|--|-------------|
| 036151 | 1-72 | | x12 - 32 mm |
| 036161 | 1-60 | | x12 - 41 mm |
| 036171 | 1-30 | | x12 - 51 mm |

Pinzas de dibujo - Color



| ref | */** | | |
|--------|--------|--|--------------------------------|
| 036250 | 15-150 | | x2 - 50 mm Colores surtidos |

Pinzas de dibujo - Negras



036550

036570

| ref | */** | | |
|--------|------|--|-------------|
| 036550 | 1-40 | | x12 - 50 mm |
| 036570 | 1-20 | | x12 - 70 mm |

Imanes

► ¡Ponga color en su oficina!

Fancy



| ref | */** | | |
|--------|--------|--|--|
| 517111 | 12-240 | x6 - Ø 13 mm Enorme fuerza de atracción | |

Dorados redondos



| ref | */** | | |
|--------|--------|--------------|--|
| 036009 | 25-625 | x8 - Ø 10 mm | |

Redondos



| ref | */** | | |
|--------|--------|----------------------------------|--|
| 051100 | 25-625 | x8 - Ø 10 mm Colores surtidos | |
| 052200 | 25-250 | x4 - Ø 22 mm Colores surtidos | |
| 052700 | 25-250 | x4 - Ø 27 mm Colores surtidos | |

051100

052200

052700

Rectangulares



| ref | */** | | |
|--------|--------|--------------------------------|--|
| 051200 | 25-300 | x8 - 27 mm Colores surtidos | |

Gomas elásticas

Color - Caja de cartón colgable



| ref | */** | | |
|--------|--------|--|--|
| 351100 | 12-216 | 50 g Colores y tamaños surtidos | |
| 351101 | 12-96 | 100 g Colores y Tamaños Surtidos | |

Cruz Color - Bolsa



| ref | */** | | |
|--------|------|----------------------------------|--|
| 351901 | 1-48 | x25 - 190 mm Colores surtidos | |

Amarillas estrechas 100 g - Caja de cartón colgable

| ref | */** | | |
|--------|-------|----------------|--|
| 351104 | 12-96 | 100 g - 60 mm | |
| 351106 | 12-96 | 100 g - 80 mm | |
| 351108 | 12-96 | 100 g - 100 mm | |
| 351110 | 12-96 | 100 g - 120 mm | |

| ref | */** | | |
|--------|-------|---|--|
| 351114 | 12-96 | 100 g - 180 mm - Hasta finales de stocks | |



Amarillas anchas 100 g - Caja de cartón colgable

| ref | */** | | |
|--------|-------|---------------------|--|
| 351502 | 12-96 | 100 g - 120 x 6 mm | |
| 351701 | 12-96 | 100 g - 120 x 10 mm | |



Amarillas estrechas 1 kg - Bolsa

| ref | */** | | |
|--------|------|--------------|--|
| 351105 | 1-16 | 1 kg - 60 mm | |
| 351107 | 1-16 | 1 kg - 80 mm | |

| ref | */** | | |
|--------|------|---------------|--|
| 351109 | 1-16 | 1 kg - 100 mm | |
| 351113 | 1-16 | 1 kg - 150 mm | |



Amarillas anchas 1 kg - Bolsa

| ref | */** | | |
|--------|------|--------------------|--|
| 351501 | 1-16 | 1 kg - 90 x 6 mm | |
| 351704 | 1-16 | 1 kg - 150 x 10 mm | |

| ref | */** | | |
|--------|------|--------------------|--|
| 351708 | 1-16 | 1 kg - 200 x 10 mm | |



Corte

► Una larga gama de herramientas de corte, adecuada tanto para principiantes como para experimentados

Escalpelos - Easy'Cut

- Seguridad
- Cuenta con cuchilla integrada
- Posición de seguridad
- Se suministra con 3 recambios



| ref | e/.. | |
|--------|--------|--|
| 009400 | 10-140 | |

Escalpelos - Soft

- Cómodo y universal
- Suavidad de la zona de apoyo
- Para las cuchillas de 6 mm y los punzones de Ø 2.4 mm
- Se suministra con 3 cuchillas



009493

009900

| ref | e/.. | |
|--------|--------|---------------|
| 009493 | 12-480 | Cuchillas x10 |
| 009900 | 10-140 | |

Herramienta de corte a 45°

- Para los cortes en bisel
- Incluye 5 cuchillas



| ref | e/.. | |
|--------|------|--|
| 172050 | 1-24 | |

Herramienta de corte a 45° y 90°

- Caja que contiene las dos herramientas de corte
- Incluye 5 cuchillas



| ref | e/.. | |
|--------|------|--|
| 172150 | 1-12 | |

Cuchillas x10

- Para MatCutter y Advanced MatCutter

| ref | e/** | | |
|--------|-------|------------------|---|
| 094593 | 5-150 | Cuchillas de 45° |  |
| 099093 | 5-150 | Cuchillas de 90° |  |



094593



099093

Kits

- ▶ Una gama completa de kits de enmarcado para todos los niveles
- ▶ Regla de aluminio graduada + accesorios

MatCutter

- Fiabilidad de corte
- 2 herramientas de corte de 45° y 90°
- Zapatas antideslizantes



| ref | e/** | | |
|--------|-------|-------|---|
| 172500 | 2-120 | 60 cm |  |

Universal MatCutter

- Fiabilidad de corte
- 2 herramientas de corte de 45° y 90°
- Zapatas antideslizantes



| ref | e/** | | |
|--------|------|-------|---|
| 172800 | 2-42 | 80 cm |  |

Reglas

► Reglas de aluminio anodizado, con los bordes de corte de acero inoxidable, especialmente diseñados para resistir al trabajo de corte

Linea

- Gran facilidad de manejo
- Para realizar cortes a mano alzada
- Estabilidad: 1 zapata antideslizante



176060



176080

| ref | e/•• | | |
|--------|--------|-------|---|
| 176060 | 10-980 | 60 cm |  |
| 176080 | 10-540 | 80 cm |  |

Profila

- Precisión y comodidad de corte
- Para cortes a mano alzada o con herramientas de corte
- Gran estabilidad: 2 zapatillas antideslizantes



177060



177080

| ref | e/•• | | |
|--------|--------|-------|---|
| 177060 | 10-980 | 60 cm |  |
| 177080 | 10-540 | 80 cm |  |

Quadra

- Precisión y comodidad de corte
- Para cortes a mano alzada o con herramientas de corte
- Seguridad: protección de los dedos en el momento del corte



178080



178100

| ref | */** | | |
|--------|------|--------|---|
| 178080 | 1-54 | 80 cm |  |
| 178100 | 1-63 | 100 cm |  |

Regleta 50 cm

- Ancho: 3 cm
- Acero inoxidable
- Graduaciones de 2 caras



| ref | */** | | |
|--------|--------|-------|---|
| 118500 | 10-100 | 50 cm |  |

Pratica 35

- Ideal para confeccionar los marcos, trazar las marcas de las agujadas o de los filetes
- Hipotenusa 35 cm
- Anchura 16 cm

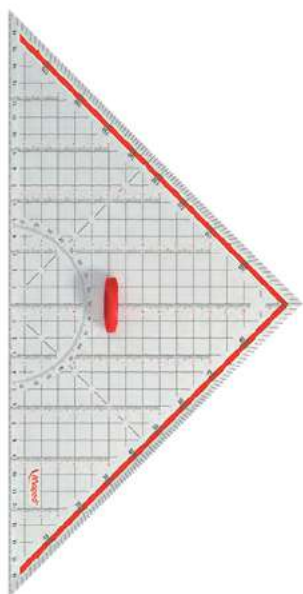

| ref | */** | | |
|--------|------|--|---|
| 147100 | 6-72 | |  |



TRADE MARKETING

ANIMACIÓN × COMUNICACIÓN × PROMOCIÓN

► Leyenda



Circuito tradicional



Gran distribución



Tiempo de montaje
del expositor



El expositor soporta
el transporte completo
(Maped no proporciona todos los
componentes necesarios para el transporte)

En el límite del stock disponible. Bajo reserva de previsiones.

Color

- Entregado vacío, o plano
- Las dimensiones vienen indicadas para un display montado (incluyendo cartelas)
- Las dimensiones de los ganchos se dan en longitud útil (espacio para colocar los productos)

Expositor de mostrador Cartón - Actividades para colorear

- Características: anchura 586 mm, profundidad 290 mm, altura 456 mm
- Incluye 1 cartela extraíble Frente/Reverso
- Hasta finales de stocks



Expositor de mostrador Cartón - Color'Peps

- Materiales: cartón procedente de madera con certificación FSC
- Características: anchura 420 mm, profundidad 290 mm, altura 320 mm
- Incluye 1 cartela extraíble y una cuña de podio
- Es posible que el pedido tenga tapa de protección de transporte (consultar con el servicio de Atención al Cliente)



| ref | •/•• | |
|--------|------|--|
| 993305 | 1-30 |  3 154 149 933051 |

| ref | •/•• | |
|--------|------|--|
| 993421 | 1-80 |  3 154 149 934218 |

1/8 de suelo – Montaje automático

- **Materiales:** cartón procedente de madera con certificación FSC
- **Características:** anchura 400 mm, profundidad 300 mm, altura 1 850 mm
- Entregado con 5 tablas de cartón



| ref | */** | |
|--------|------|---|
| 998383 | 1-37 |  |

1/4 de suelo – Cartón – Colorear

- **Características:** anchura 600 mm, profundidad 400 mm, altura 1 265 mm
- Es posible que el pedido tenga tapa de protección de transporte (consultar con el servicio de Atención al Cliente)
- Hasta finales de stocks



| ref | */** | |
|--------|------|---|
| 304026 | 1-38 |  |

1/4 de suelo – Cartón

- **Materiales:** cartón procedente de madera con certificación FSC
- **Características:** anchura 600 mm, profundidad 400 mm, altura 1 900 mm
- Entregado con 4 tablas de cartón



| ref | */** | |
|--------|------|---|
| 304035 | 1-20 |  |

Suelo – Metal

- **Características:** anchura 380 mm, profundidad 380 mm, altura 1 880 mm
- Incluye 27 ganchos metal con porta precios de 12,5 cm



| ref | */** | |
|--------|------|---|
| 304020 | 1-6 |  |
| 304021 | 1-6 | Pack de 6 tablas  |
| 304033 | 1- | Lot de 15 ganchos  |

Escolar y escritura

- ▶ Entregado vacío, o plano
- ▶ Las dimensiones vienen indicadas para un display montado (incluyendo cartelas)
- ▶ Las dimensiones de los ganchos se dan en longitud útil (espacio para colocar los productos)

Expositor de mostrador - Cartón - Pastel

- **Materiales:** cartón procedente de madera con certificación FSC
- **Características:** anchura 420 mm, profundidad 290 mm, altura 320 mm
- Incluye 1 cartela extraíble y una cuña de podio
- Es posible que el pedido tenga tapa de protección de transporte (consultar con el servicio de Atención al Cliente)



| | | |
|--------|------|---|
| ref | e/** | |
| 993420 | 1-80 |  3 154149 934201 |

Expositor de mostrador - Cartón - Colecciones

- **Materiales:** cartón procedente de madera con certificación FSC
- **Características:** anchura 420 mm, profundidad 290 mm, altura 320 mm
- Incluye 2 cartelas extraíbles: 1 Mini Cute, 1 Nightfall, una cuña de podio y una caja
- Es posible que el pedido tenga tapa de protección de transporte (consultar con el servicio de Atención al Cliente)



| | | |
|--------|------|---|
| ref | e/** | |
| 993419 | 1-80 |  3 154149 934195 |

Suelo - Cartón - Estuche XXL

- **Materiales:** cartón procedente de madera con certificación FSC
- **Características:** anchura 600 mm, profundidad 400 mm, altura 1 900 mm
- **Incluye 1 cartela extraíble Frente francés/Reverso inglés, 2 tapones Frente/Reverso inglés y español y 2 stoppers para lineal**



NEW!



| ref | */** | |
|-----------------|------|---|
| 304005 | 1- |  |
| 3 154143 040052 | | |

1/8 de suelo - Cartón Colecciones

- **Materiales:** cartón procedente de madera con certificación FSC y espalda de cartón duro
- **Características:** anchura 400 mm, profundidad 300 mm, altura 1 850 mm
- **Incluye 9 ganchos porta precios de metal de 15 cm, 3 cartelas (1 Mini Cute, 1 Nightfall y 1 Smiling Planet) y 1 baja comunicación Nightfall**



| ref | */** | |
|-----------------|------|---|
| 998385 | 1-20 |  |
| 3 154149 983858 | | |

Expositor - Metal

- **Características:** anchura 410 mm, profundidad 200 mm, altura 820 mm
- **Incluye 9 ganchos metal de 10 cm y 6 tablas de acrílico de 19 cm de ancho**
- **Entregado con 2 pegatinas de comunicación y 1 cartela extraíble**



| ref | */** | |
|---|------|-------------------|
| 303710 | 1-8 | Oficina y Escolar |
|  | | |
| 3 154143 037106 | | |

1/8 de suelo - Cartón

- **Materiales:** cartón procedente de madera con certificación FSC y espalda de cartón duro
- **Características:** anchura 400 mm, profundidad 300 mm, altura 1 850 mm
- Incluye 9 ganchos porta precios de metal de 15 cm, 2 tablas



300381



998312



300385

| ref | */** | | |
|--------|------|--------------------------------------|--|
| 300381 | 1-20 | Escolar | |
| 998312 | 1-20 | Oficina - Hasta finales de stocks | |
| 300385 | 1-9 | Lot de 9 ganchos porta precios 15 cm | |

1/8 de suelo - Cartón - A granel

- **Características:** anchura 380 mm, profundidad 280 mm, altura 1 050 mm
- **Entregado con 1 cartela:** comunicación transversal escolar



1/4 de suelo - Cartón - A granel

- **Materiales:** cartón procedente de madera con certificación FSC
- **Características:** anchura 600 mm, profundidad 400 mm, altura 1 050 mm
- **Entregado con 1 cartela:** comunicación transversal escolar



| ref | */** | | |
|--------|------|--|--|
| 992414 | 1-16 | | |

| ref | */** | | |
|--------|------|--|--|
| 301001 | 1-10 | | |

1/4 de suelo – Impulse

- **Materiales:** cartón procedente de madera con certificación FSC, plástico
- **Características:** anchura 600 mm, profundidad 400 mm, altura 1 500 mm
- **Entregado con 2 tablas de cartón**



| ref | */** | |
|--------|------|---|
| 304010 | 1-6 |  |



1/4 de suelo – A granel

- **Materiales:** cartón procedente de madera con certificación FSC, PET reciclado
- **Características:** anchura 600 mm, profundidad 400 mm, altura 1 500 mm
- **Entregado con 2 tablas de cartón**
- **Entregado con 2 cartelas:** Escolar y Smiling Planet



| ref | */** | |
|--------|------|---|
| 304011 | 1-23 |  |

1/4 de suelo – Cartón

- **Espalda:** cartón duro
- **Características:** anchura 600 mm, profundida 400 mm, altura 1 500 mm
- **Incluye 26 ganchos porta precios de 25 cm, 1 cartela comunicación transversal escolar**



| ref | */** | |
|--------|------|---|
| 995400 | 1-14 |  |

1/4 de suelo – Metal

- Características: anchura 680 mm, profundidad 400 mm, altura 1 850 mm
- Ultraflexible
- Compatible con tabletas acrílicas, bomboneras o ganchos porta precios 28 cm, elemento suplementario
- Entregado con 1 cartela: comunicación transversal escolar



970001



970070

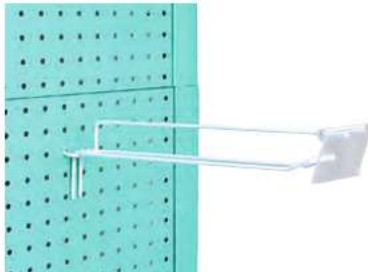

970080

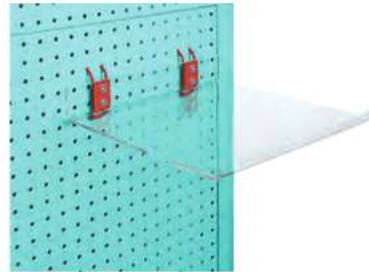

970090

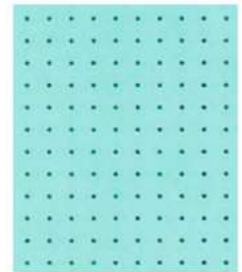

970061

| ref | */** | | |
|--------|------|--|---|
| 970001 | 1-3 | |  |
| 970070 | 1-6 | Pack de 2 bomboneras de plástico Capacidad 2 inners |  |
| 970080 | 1-6 | Pack de 15 ganchos porta precios 28 cm |  |
| 970090 | 1-8 | Pack de 5 tabletas acrílico 30 cm |  |
| 970061 | 1- | Elemento en metal suplementario |  |
| 970015 | 1- | Kit de comunicación Color Peps (cartela y mejillas) Cartón procedente de madera con certificación FSC |  |



970015

Expositor de mostrador - A granel

- **Materiales:** cartón procedente de madera con certificación FSC, PET reciclado
- **Características:** anchura 320 mm, profundidad 200 mm, altura 480 mm
- Incluye un kit de comunicación de la gama para zurdos y un kit de comunicación Smiling Planet



ref */**
993422 1-100



3 154 149 934225

Expositor de mostrador - Impulse

- **Material:** acrílico
- **Características:** anchura 410 mm, profundidad 200 mm, altura 820 mm



ref */**
993511 1-16



3 154 149 935116

Expositor de mostrador - Trazado

- **Material:** metal
- Fácil de recargar
- **Características:** anchura 350 mm, profundidad 230 mm, altura 750 mm
- Hasta finales de stocks



ref */**
120000 1-12



3 154 141 200007

Expositor de mostrador - Escritura

- Material : acrílico
- Capacidad : 36 a 144 lápices (según la composición)
- Entregado 2 comunicación Frente/Reverso (Black'Peps, Fluo Peps, Graph'Peps, Multi escritura)
- Características : anchura 180 mm, profundidad 245 mm, altura 285 mm
- Disponible en "make to order"



| ref | */** | Barcode |
|--------|------|-----------------|
| 993306 | 1-24 | 3 154149 933068 |

Expositor de mostrador - Fluo Peps 200

- Materiales : acrílico y plexiglás
- Capacidad máxima : 200 subrayadores fluorescentes
- Surtido modurable : Fluo'Peps Classic, Soft, Max, Pen & Pocket y Roller
- Características : anchura 230 mm, profundidad 170 mm, altura 380 mm
- Hasta finales de stocks



| ref | */** | Barcode |
|--------|------|-----------------|
| 898911 | 1-6 | 3 154148 989110 |

Expositor de mostrador - Black'Peps

- Materiales: acrílico - plexiglás
- Capacidad máxima: 288 lápices
- Características: anchura 225 mm, profundidad 152 mm, altura 475mm



| ref | */** | Barcode |
|--------|------|-----------------|
| 896610 | 1-6 | 3 154148 966104 |

Expositor de mostrador - Fluo Peps 74

- Material: polipropileno
- Capacidad máxima: 74 subrayadores fluorescentes
- Surtido modurable: Fluo Peps Classic, Flex
- Características: anchura 215 mm, profundidad 95 mm, altura 430 mm
- Disponible durante 2023



| ref | */** | Barcode |
|--------|------|-----------------|
| 898910 | 1-30 | 3 154148 989103 |

Expositor de mostrador - Fluo Peps Pastel 74

- Material: polipropileno
- Capacidad máxima: 74 subrayadores fluorescentes
- Surtido modulado: Fluo Peps Classic Pastel & Glitter
- Características: anchura 215 mm, profundidad 95 mm, altura 430 mm
- Disponible durante 2023



NEW!



| ref | */** | |
|--------|------|---|
| 898913 | 1-30 |  3 154148 989134 |

PLV

Clip Strip

- Características: anchura 120 mm, profundidad 2 mm, altura 859 mm
- Capacidad: 12 productos
- Entregado con 1 clip
- Nueva carta disponible durante 2023



Decoración expositor productos Maped

- Características cartela: anchura 900 mm, profundidad 5 mm, altura 425 mm
- Características mejillas: anchura 375 mm, profundidad 5 mm, altura 1 700 mm



| ref | */** | |
|--------|--------|---|
| 992730 | 25-225 |  3 154149 927302 |

| ref | */** | |
|--------|------|---|
| 992493 | 1-50 |  3 154149 924936 |

Decoración expositor productos Maped Color'Peps

- Características cartela: anchura 900 mm, profundidad 5 mm, altura 425 mm
- Características mejillas: anchura 375 mm, profundidad 5 mm, altura 1 700 mm



| ref | •/•• | |
|--------|------|--|
| 992499 | 1-30 |  3 154 149 924998 |

Pegatinas

- Materiales de las pegatinas del suelo: PVC antideslizante y pegamento especial para el suelo
- Pegatinas de pared y para vitrinas: adhesivo removible
- Características Rayuela: anchura 575 mm, altura 1490 mm
- Características Suelo Maped: anchura 500 mm, altura 300 mm
- Características 3D Tijeras: anchura 500 mm, altura 300 mm
- Características Small size: anchura 300 mm, altura 200 mm
- Características Shop window: anchura 1500 mm, altura 1500 mm



992728



992484



992904



992736

| ref | •/•• | | |
|--------|-------|------------------------------|--|
| 992728 | 5- | Pegatina de suelo rayuela |  3 154 149 927289 |
| 992484 | 5- | Pegatina de suelo Maped |  3 154 149 924844 |
| 992904 | 5-150 | Pegatina de suelo 3D Tijeras |  3 154 149 929047 |
| 992736 | 5-250 | Tamaño pequeño |  3 154 149 927364 |
| 992737 | 1-77 | Shop window |  3 154 149 927371 |



992737

| REF. | página | REF. | página | REF. | página | REF. | página | REF. | página | REF. | página |
|-----------|---------|-----------|--------|-----------|----------|-----------|--------|-----------|---------|-----------|---------|
| 001601 | 81 | 036250 | 238 | 106411 | 96 | 191510 | 131 | 245610 | 119 | 351109 | 240 |
| 001700 | 89 | 036550 | 238 | 106419 | 96 | 191511 | 131 | 245611 | 119 | 351110 | 240 |
| 006301 | 92 | 036570 | 238 | 106711 | 96 | 191610 | 131 | 245612 | 119 | 351113 | 240 |
| 006303 | 79 | 036910 | 138 | 106712 | 96 | 191611 | 131 | 245620 | 119 | 351114 | 240 |
| 006600 | 81 | 037090 | 92 | 112513 | 101 | 191612 | 18 | 245631 | 121 | 351501 | 240 |
| 006700 | 81 | 037100 | 212 | 112520FM | 11 | 191613 | 18 | 245710 | 121 | 351502 | 240 |
| 006800 | 85 | 037310 | 92 | 112521FM | 11 | 191690 | 131 | 245801 | 121 | 351701 | 240 |
| 006900 | 86 | 037400 | 235 | 112911 | 104 | 192511 | 133 | 245910 | 121 | 351704 | 240 |
| 007100 | 82 | 037800 | 150 | 112921 | 104 | 192608 | 148 | 254330 | 111 | 351708 | 240 |
| 009400 | 241 | 037910 | 151 | 113050 | 98 | 192610 | 133 | 255110 | 124 | 351901 | 240 |
| 009493 | 241 | 038700 | 144 | 113053 | 98 | 192611 | 133 | 255400 | 129 | 352110 | 207 |
| 009900 | 241 | 039100 | 232 | 113290 | 102 | 193115 | 24 | 258010 | 13, 161 | 352111 | 207 |
| 010013FM | 105 | 039200 | 204 | 115910 | 97 | 194102 | 137 | 258190 | 122 | 352190 | 207 |
| 010030FM | 106 | 039300 | 232 | 115911 | 97 | 194111 | 137 | 258500 | 160 | 352210 | 207 |
| 010033FM | 106 | 039630 | 237 | 115912 | 97 | 194500 | 137 | 258510 | 160 | 352211 | 207 |
| 010450 | 106 | 039640 | 237 | 115920 | 99 | 194510 | 137 | 258520 | 164 | 352290 | 207 |
| 010710FM | 106 | 040300 | 197 | 116050 | 98 | 194609 | 147 | 258530 | 164 | 352311 | 200 |
| 010715FM | 105 | 040400 | 197 | 116052 | 98 | 195110 | 136 | 258550 | 164 | 352411 | 200 |
| 010716FM | 105 | 040701 | 159 | 116114 | 23 | 195208 | 148 | 258600 | 165 | 352510 | 208 |
| 010725FM | 106 | 040702 | 159 | 116115 | 23 | 195210 | 136 | 258608 | 129 | 352511 | 208 |
| 010762FM | 106 | 041710 | 81 | 116411 | 96 | 196100 | 140 | 258890 | 123 | 352513 | 208 |
| 011010 | 101 | 041712 | 81 | 116412 | 96 | 196101 | 140 | 258990 | 123 | 352611 | 200 |
| 011300 | 98 | 043110 | 92 | 116610 | 99 | 196102 | 140 | 277620 | 129 | 353010 | 198 |
| 011301 | 97 | 043111 | 92 | 118200 | 128 | 196210 | 140 | 277737 | 128 | 353011 | 198 |
| 011305 | 98 | 043500 | 203 | 118300 | 128 | 196310 | 141 | 277747 | 128 | 353210 | 198 |
| 011309 | 98 | 044115 | 16 | 118500 | 128, 244 | 196510 | 139 | 278610 | 114 | 353211 | 198 |
| 011320 | 102 | 044116 | 16 | 119001 | 104 | 196608 | 149 | 278611 | 114 | 353410 | 199 |
| 011600 | 97 | 044200 | 204 | 119002 | 104 | 196610 | 141 | 278710 | 114 | 353411 | 199 |
| 011722 | 97 | 044600 | 203 | 119405 | 136 | 197510 | 134 | 278810 | 118 | 353611 | 199 |
| 011724 | 97 | 044900 | 203 | 119409 | 148 | 197512 | 134 | 278910 | 118 | 354300 | 195 |
| 012000 | 107 | 045200 | 216 | 119410 | 135 | 197513 | 134 | 279010 | 116 | 354301 | 204 |
| 012403 | 100 | 046015 | 23 | 119418 | 148 | 197514 | 134 | 279110 | 116 | 354311 | 201 |
| 012511 | 107 | 046017 | 23 | 119430 | 136 | 199111 | 135 | 279115 | 115 | 354411 | 201 |
| 012802 | 187 | 049110 | 93 | 119450 | 135 | 199113 | 149 | 279190 | 116 | 354510 | 205 |
| 012806 | 187 | 049111 | 93 | 119518 | 17 | 199121FM | 11 | 279210 | 116 | 354511 | 205 |
| 014100 | 90 | 049112 | 16 | 119519 | 17 | 199190 | 135 | 279215 | 115 | 354512 | 205 |
| 014111 | 90 | 049113 | 16 | 120000 | 252 | 199511 | 135 | 279290 | 116 | 354513 | 205 |
| 014501 | 102 | 049120 | 93 | 120030 | 126 | 199590 | 135 | 279315 | 115 | 361211 | 236 |
| 015501 | 17, 103 | 049121 | 93 | 120040 | 126 | 199591FM | 11 | 279317 | 17 | 369000 | 138 |
| 015502 | 17, 103 | 049130 | 93 | 120050 | 126 | 220002 | 26 | 279390 | 116 | 370110 | 212 |
| 015503 | 17, 103 | 049131 | 93 | 120120 | 126 | 221200 | 167 | 279410 | 116 | 370111 | 212 |
| 015801 | 103 | 049190 | 93 | 120130 | 126 | 221210 | 186 | 279710 | 118 | 392510 | 233 |
| 015802 | 103 | 049210 | 94 | 120159 | 126 | 221220 | 187 | 279711 | 118 | 392710 | 198 |
| 015901 | 103 | 049211 | 94 | 120421 | 126 | 221310 | 185 | 279810 | 116 | 395110 | 233 |
| 016610 | 87 | 049220 | 94 | 120510 | 101 | 221910 | 187 | 280110 | 127 | 395211 | 232 |
| 016611 | 87 | 049221 | 94 | 120511 | 101 | 222210 | 185 | 281018 | 24 | 400111 | 215 |
| 017610 | 89 | 049230 | 94 | 120621 | 127 | 222212 | 185 | 282030 | 114 | 400112 | 217 |
| 017611 | 89 | 049231 | 94 | 121651 | 142 | 222702 | 167 | 290310 | 146 | 401111 | 214 |
| 017690 | 89 | 049311 | 93 | 122010 | 107 | 222710 | 186 | 291010 | 146 | 401131 | 214 |
| 017691 | 89 | 049411 | 94 | 122011 | 107 | 222720 | 187 | 291013 | 146 | 402311 | 214 |
| 017710 | 90 | 049411 | 105 | 122090 | 107 | 224320 | 185 | 291091 | 146 | 402400 | 196 |
| 017711 | 90 | 051100 | 239 | 122091 | 107 | 224430NE | 184 | 300381 | 249 | 402411 | 214 |
| 017790 | 90 | 051110 | 87 | 122811 | 105 | 224431NE | 184 | 300385 | 249 | 403000 | 197 |
| 017810 | 90 | 051111 | 87 | 123210 | 102 | 224432NE | 184 | 301001 | 249 | 403001 | 197 |
| 017811 | 90 | 051200 | 239 | 123211 | 102 | 224434NE | 184 | 303710 | 248 | 403411 | 214 |
| 018100 | 130 | 052200 | 239 | 123290 | 102 | 224435NE | 184 | 304005 | 248 | 404000 | 197 |
| 018111 | 130 | 052700 | 239 | 127710 | 104 | 224436NE | 184 | 304010 | 250 | 404002 | 197 |
| 018112 | 87 | 058700 | 165 | 127711 | 104 | 225430NE | 185 | 304011 | 250 | 404041 | 26 |
| 018113 | 87 | 060210 | 92 | 128010 | 187 | 229120 | 184 | 304020 | 246 | 404091 | 197 |
| 018114 | 87 | 060211 | 92 | 129200 | 127 | 229130 | 184 | 304021 | 246 | 404411 | 215 |
| 018119 | 147 | 061000 | 216 | 134210 | 145 | 229445 | 26 | 304026 | 246 | 406411 | 215 |
| 018211 | 228 | 062000 | 216 | 137702 | 150 | 236110 | 121 | 304033 | 246 | 421510 | 217 |
| 018310 | 229 | 062210 | 82 | 137910 | 151 | 236210 | 121 | 304035 | 246 | 440010 | 202 |
| 018311 | 229 | 062211 | 82 | 146108 | 108 | 240011 | 130 | 305811 | 142 | 440110 | 202 |
| 018410 | 89 | 062511 | 79 | 146109 | 108 | 240013 | 130 | 305812 | 142 | 440210 | 202 |
| 018411 | 89 | 062911 | 80 | 146112 | 108 | 240014 | 130 | 310011 | 236 | 440600 | 204 |
| 018490 | 89 | 063011 | 79 | 146114 | 108 | 240115 | 130 | 311011 | 236 | 442110 | 210 |
| 019110 | 131 | 063021FM | 11 | 146115 | 108 | 242020 | 111 | 314600 | 141 | 447411 | 206 |
| 019409 | 148 | 063210 | 80 | 146119 | 108 | 242030 | 111 | 320011 | 236 | 450010 | 210 |
| 019600 | 139 | 063211 | 80 | 146120 | 109 | 242040 | 111 | 321011 | 236 | 450510 | 209 |
| 020612FM | 105 | 063310 | 82 | 146122 | 109 | 242120 | 111 | 322230 | 237 | 450810 | 209 |
| 021109 | 101 | 063311 | 82 | 146123 | 109 | 242130 | 111 | 322320 | 237 | 451211 | 213 |
| 021789 | 100 | 063511 | 80 | 146134 | 109 | 242180 | 113 | 322330 | 237 | 452211 | 214 |
| 021792 | 100 | 067510 | 95 | 146507 | 108 | 242360 | 113 | 322420 | 237 | 452511 | 213 |
| 024009 | 141 | 068650 | 226 | 147100 | 244 | 242421 | 112 | 323705 | 211 | 455211 | 208 |
| 027330 | 95 | 068800 | 226 | 147526 | 112 | 242426 | 112 | 323805 | 211 | 464210 | 152 |
| 027900 | 116 | 069300 | 154 | 147527 | 112 | 242621 | 112 | 324104 | 211 | 464212 | 152 |
| 028600 | 128 | 069600 | 157 | 169300 | 154 | 242626 | 112 | 324105 | 211 | 464216 | 18 |
| 028700 | 128 | 071420FM | 10 | 169600 | 157 | 242767 | 113 | 324106 | 211 | 464217 | 18 |
| 030110 | 91 | 071421FM | 10 | 172050 | 241 | 242815 | 110 | 324401 | 211 | 464290 | 152 |
| 030111 | 91 | 071450 | 86 | 172150 | 241 | 242820 | 110 | 324402 | 211 | 464310 | 152 |
| 030210 | 91 | 071451 | 86 | 172500 | 242 | 242830 | 110 | 324405 | 211 | 464312 | 152 |
| 030211 | 91 | 071520FM | 10 | 172800 | 242 | 244020 | 122 | 324502 | 211 | 464410 | 152 |
| 030290 | 91 | 071521FM | 10 | 176060 | 243 | 244030 | 122 | 324604 | 211 | 464411 | 152 |
| 032020 | 237 | 071550 | 86 | 176080 | 243 | 244040 | 122 | 324605 | 211 | 464412 | 152 |
| 032060 | 237 | 071551 | 86 | 177060 | 243 | 244060 | 122 | 324606 | 211 | 464413 | 152 |
| 032061 | 237 | 085110 | 230 | 177080 | 243 | 244069 | 125 | 324806 | 211 | 466916 | 25 |
| 032191 | 83 | 085910 | 230 | 178001 | 143 | 244120 | 123 | 325202 | 211 | 466917 | 25 |
| 032210 | 83 | 086010 | 229 | 178002 | 143 | 244130 | 123 | 325305 | 212 | 468002 | 196 |
| 032211 | 83 | 086110 | 229 | 178080 | 244 | 244180 | 124 | 326205 | 212 | 468010 | 221 |
| 032710 | 84 | 086410 | 230 | 178100 | 244 | 244304 | 125 | 326402 | 212 | 468011 | 221 |
| 032711 | 84 | 086510 | 230 | 178101 | 143 | 244421 | 124 | 326602 | 212 | 468101 | 196 |
| 033100 | 213 | 086610 | 230 | 178102 | 143 | 244621 | 124 | 330011 | 236 | 468110 | 221 |
| 034012 | 85 | 086710 | 230 | 181510 | 132 | 245011 | 24 | 339410 | 213 | 468111 | 221 |
| 034013 | 85 | 089093 | 231 | 181511 | 132 | 245301 | 122 | 342011 | 236 | 468210 | 221 |
| 034014 | 85 | 089301 | 231 | 181610 | 132 | 245310 | 119 | 345011 | 236 | 468310 | 221 |
| 034019 | 81 | 092211 | 228 | 181611 | 132 | 245312 | 119 | 346011 | 236 | 469216 | 25 |
| 035090 | 84 | 092213 | 228 | 183212 | 47 | 245320 | 119 | 351100 | 240 | 470010 | 155 |
| 036009 | 239 | 092310 | 229 | 183213 | 50 | 245401 | 122 | 351101 | 240 | 472020FM | 12, 151 |
| 036100 | 238 | 092311 | 229 | 183218 | 47 | 245410 | 119 | 351104 | 240 | 472021FM | 12, 151 |
| 036102 | 238 | 094593 | 242 | 183218FC | 48 | 245412 | 119 | 351105 | 240 | 472110 | 150 |
| 036151 | 238 | 099093 | 242 | 183218FC | 48 | 245420 | 119 | 351106 | 240 | 472112 | 150 |
| 036161 | 238 | 103700 | 100 | 183224 | 47 | 245421 | 121 | 351107 | 240 | 472520FM | 12, |

REF. página

473110 153
 473112 153
 • 473120FM 12
 • 473121FM 12
 • 473190 153
 • 476202FM 12, 156
 476110 155
 476112 155
 • 476520FM 13, 156
 484211 154
 484213 154
 • 484290 154
 • 484291 154
 484410 154
 484412 154
 • 484490 154
 • 484590 154
 486214 157
 • 486290 157
 • 486291 157
 • 496110 223
 • 496111 222
 496210 223
 • 498110 223
 • 498111 222
 • 499110 223
 • 499111 222
 499210 223
 501600 81
 501700 89
 503700 92
 506300 79
 506600 81
 506700 81
 506800 85
 506900 86
 • 507100 82
 511010 101
 511100 101
 511320 102
 511710 99
 511780 100
 511790 100
 512000 107
 512500 107
 512511 107
 517111 239
 • 518100 130
 • 518110 130
 519118 147
 519119 147
 519143 131
 533100 213
 534019 81
 • 534753 84
 • 534754 83
 • 534755 84
 534756 83
 536919 149
 536953 138
 536955 139
 537100 212
 537300 235
 537500 234
 538700 144
 538705 144
 538717 145
 539300 232
 • 540300 197
 • 540400 197
 544500 210
 559511 178
 559530 178
 559533 178
 559541 178
 559553 178
 559610 177
 559630 177
 559911 179
 559930 179
 559933 179
 559936 179
 559941 179
 560410 177
 560430 177
 564040 178
 564053 178
 564140 178
 564153 178
 565000 220
 575100 234
 575200 234
 575400 234
 583510 160
 583712 159
 • 584610 165
 • 586010 165
 • 586110 164
 • 593500 164
 593501 164
 595010 156
 596110 225
 • 596190 225
 597110 225

REF. página

• 599110 225
 599190 225
 601003 158
 601005 158
 601006 158
 601010 158
 611411 121
 620310 218
 620311 218
 620312 218
 622511 219
 630310 219
 630311 219
 630700 235
 630725 235
 631760 203
 • 634753 84
 634754 83
 • 634755 84
 634756 83
 640717 230
 640721 230
 653510 220
 656510 220
 670110 153
 670112 153
 • 670190 153
 681700 155
 684110 227
 686110 227
 • 686600 222
 • 688102 222
 690210 226
 692110 227
 692310 228
 693500 154
 693501 154
 695510 227
 696510 157
 697710 227
 697910 228
 733030 194
 733031 194
 733032 194
 733033 194
 733047 194
 733530 194
 733531 194
 733532 194
 733547 194
 734027 191
 734033 191
 734034 191
 734035 191
 734036 191
 734127 191
 734128 191
 734133 191
 734135 191
 734136 191
 734150 193
 734511 193
 734517 193
 734530 193
 734531 193
 734547 193
 735030 163
 735031 163
 735032 163
 735033 163
 735047 163
 735530 163
 735531 163
 735532 163
 735547 163
 740300 188
 740301 188
 740302 188
 • 740308 188
 • 740310 188
 740700 26
 • 740901 190
 • 740902 190
 741310LM 161
 741311LM 161
 741312LM 161
 741804 161
 741815 161
 741817 162
 741830LM 161
 741831LM 161
 741832LM 161
 741845 162
 742000 167
 742028 167
 742038 167
 742046 167
 742524 189
 742528 190
 742530 189
 742531 189
 742533 189
 742534 189
 742535 189

REF. página

742536 189
 742537 189
 742538 190
 742546 190
 742547 189
 742549 189
 742557 189
 742558 190
 742567 189
 742570 190
 742571 190
 742576 190
 742728 192
 742730 192
 742732 192
 742733 192
 742734 192
 742735 192
 742737 192
 742777 192
 742924 192
 742934 192
 742937 192
 742947 192
 743517 162
 743547 162
 743638 19
 743677 19
 745937 193
 745947 193
 746325 193
 746326 193
 746337 193
 • 749000 181
 • 749001 181
 • 749002 181
 • 749003 181
 749020 181
 749040 180
 749041 180
 749043 180
 749044 180
 749048 181
 749050 181
 749051 181
 749105 182
 749108 182
 749111 182
 749117 182
 749118 182
 749120 182
 749140 182
 749141 182
 749143 182
 749144 182
 749150 182
 749151 182
 749155 183
 749158 182
 749250 183
 749450 183
 • 749602 179
 749620 179
 749627 179
 749652 179
 • 750001 235
 810010 65
 810011 65
 810012 65
 810510 65
 810520 65
 810540 65
 811310 66
 811410 67
 811520 66
 812510 33
 813010 61
 820310 33
 820410 67
 829600 59
 • 829600FC 59
 829601 59
 • 829601FC 59
 829602 59
 • 829602FC 59
 831210 69
 831211 70
 831212 70
 831214 70
 831216 71
 831217 71
 831218 72
 • 831222 72
 • 831223 72
 831224 67
 831225 68
 831226 68
 831227 69
 • 831228 70
 831700 21
 831702 21
 • 831800FC 10
 • 832000 54
 832002 47
 832003 49

REF. página

• 832004 54
 832014 51
 832015 51
 832016 51
 832017 47
 • 832017FC 48
 832030 54
 832021 50
 832023 50
 832032 46
 • 832034 54
 832035 46
 832048 47
 • 832048FC 48
 832058 51
 • 832069FC 49
 832071 49
 832072 47
 832212 52
 • 832212FC 53
 832218 52
 • 832218FC 53
 832224 52
 • 832224FC 53
 832271 50
 832272 50
 832500 49
 832824 58
 834010 31
 • 834010FC 31
 834012FC 31
 834013 31
 • 834013FC 31
 • 834030 54
 836011 60
 836012 60
 836013 60
 836306 63
 836310 63
 838510 177
 844400 22
 844402 22
 844612 55
 844705 55
 844820 58
 845000LM 54
 845004LM 54
 845015 34
 845017 34
 845020 34
 845021 34
 845022 34
 845045 34
 845230LM 54
 845400 37
 845401 37
 845403 37
 845404 16
 845406 16
 • 845420 35
 845421 35
 • 845422 35
 845435 36
 845445 36
 845469 37
 • 845700 39
 • 845701 39
 • 845703 39
 • 845704 39
 845720 38
 845721 38
 845722 38
 845723 38
 845724 38
 845725 38
 • 845726 38
 • 845727 39
 • 846020 32
 846222 32
 846612 56
 846808 55
 847010 57
 847110 56
 848010 57
 849010 57
 850011 171
 • 850011FC 168
 • 850017FC 168
 850018 174
 850021 171
 • 850021FC 168
 850022 171
 • 850022FC 168
 850023 171
 • 850023FC 168
 850024 171
 • 850024FC 168
 850025 171
 • 850025FC 168
 850031 171
 • 850031FC 168
 850032 171
 850040 171

REF. página

• 850040FC 168
 850059 171
 • 850059FC 168
 850060 174
 850211 145, 172
 850811 176
 • 850821 176
 850822 176
 850831 176
 850859 176
 851711 172
 • 851711FC 169
 851712 172
 851718 174
 851719 173
 851721 172
 • 851721FC 169
 851722 172
 • 851722FC 169
 851723 172
 • 851723FC 169
 851724 172
 • 851724FC 169
 851725 172
 • 851725FC 169
 851730 173
 851731 172
 • 851731FC 169
 851732 172
 851732FC 169
 851740 172
 • 851740FC 169
 851759 172
 • 851759FC 169
 851760 174
 851769 173
 • 851803 166
 • 851804 166
 • 851805 166
 851807 25
 851808 18
 851811 176
 851813 25
 851814 18
 • 851821 176
 851822 176
 851831 176
 851859 176
 851873 25
 851874 18
 • 852000 173
 • 852001 173
 • 852002 173
 854021 175
 854041 175
 854059 175
 854721 175
 854741 175
 854759 175
 860612 61
 861011 62
 861012 62
 861013 62
 861311 32
 • 861600 41
 • 861601 41
 • 861602 41
 • 861604 41
 • 861605 42
 • 861606 42
 • 861607 42
 862011 62
 862013 62
 862201 15
 862203 15
 • 862612 51
 • 862624 51
 • 862712 43
 • 862714 45
 • 862715 45
 • 862716 45
 • 862718 43
 • 862723 45
 • 862724 43
 • 862725 45
 • 862744 46
 • 862745 46
 • 862746 46
 • 862812 43
 • 863312 43
 863806 30
 864010 63
 864011 63
 864012 63
 867810 66
 871299 27
 • 872503 13
 888610 231
 894110 231
 894910 231
 895024 117
 895055 117
 896610 253
 • 897118 113

REF. página

• 897120 125
 897121 110
 897157 117
 897158 117
 897412 35
 897416 33
 897417 183
 897523 177
 898011 206
 898014 201
 • 898910 253
 898911 253
 • 898913 254
 899704 78
 899705 78
 899707 78
 899789 19
 899799 27
 907003 64
 922410 129
 • 931900 75
 • 931901 75
 • 931902 75
 • 931903 75
 • 931904 75
 • 931905 75
 • 931906 75
 • 931907 75
 • 931908 75
 932213 21
 934726 76
 934755 76
 934803 15
 934804 15
 934836 76
 934839 76
 934850 76
 934851 76
 935020 164
 935021 164
 936010 61
 • 936100 8
 953511 199
 967413 77
 967430 77
 967431 77
 967434 77
 967811 77
 967812 77
 967813 77
 967814 77
 967816 77
 970001 251
 970015 251
 970061 251
 970070 251
 970080 251
 970090 251
 981701 120
 981703 120
 981704 120
 981705 120
 981706 120
 981707 120
 981710 121
 981722 118
 981727 150
 981792 121
 981828 17
 981831 23
 984701 38
 984718 37
 984722 64
 • 984729 . . .



- A**
- A la moda y lúdicos - Sacapuntas 87-90
 - Abrecartas 235
 - Accesorios - Escolares 159
 - Accesorios de oficina 234-235
 - Accesorios - Escritura 187
 - Accesorios - Pintura 66
 - Accesorios de compases - Compases 145
 - Actividades para colorear 67-72
 - Advanced - Sacapuntas 95
 - Advanced Gel - Tijeras 223
 - Advanced Green - Tijeras 223
 - Advanced Metal - Grapadoras 205-206
 - Advanced Metal - Perforadores 218-219
 - Advanced Metal - Pinzas grapadoras 206
 - Advanced Wood - Tijeras 222
 - Alfileres 236
 - Almohadilla de tinta 235
 - Aluminium - Trazado 126-127
 - Architecte - Gomas 101
 - Artículos de fijación 237-240
 - Automático - Portaminas 178-179
- B**
- Baby Crayons - Gama 1ª Edad 30
 - Ball'Peps - Bolígrafos 184-185
 - Bata de protección - Gama 1ª Edad 33
 - Bata de protección - Pintura 67
 - Bigoteras - Compases 146
 - Black'Peps - Decorados lápices de grafito 173-174
 - Black'Peps - Lápices de grafito 168-176
 - Black'Peps - Portaminas 177-179
 - Black'Peps Energy - Lápices de grafito 173
 - Black'Peps Glitter - Lápices de grafito 166
 - Black'Peps Jumbo - Lápices de grafito 175
 - Black'Peps lápices de grafito (FSC certificado) 168-169
 - Black'Peps Navy - Lápices de grafito 176
 - Black'Peps Pastel - Lápices de grafito 173
 - Bolígrafos recargables 185-187
 - Bolsa de tela para colorear 69
 - Boogy - Sacapuntas 80, 82
 - Borradores 187
 - Bote para agua - Pintura 66
 - Botellas - Pintura 65
 - Bulbo - Sacapuntas 82
- C**
- Caja abre fácil 236
 - Cajas metálica - Lápices de colores Strong 45
 - Cartuchos 187
 - Caucho natural - Gomas 105-106
 - Cepillos y esponjas - Pizarras 164-165
 - Cera de colores - Wax - Gama 1ª Edad 32
 - Chinchetas 236
 - Cizalla y Guillotinas 231
 - Clásico - Sacapuntas 81
 - Clásicos - Gomas 96-100
 - Clásicos - Sacapuntas 83-86
 - Classic - Plumas estilográficas 185
 - Classic - Trazado 108-110
 - Classic blanca - Pizarras 160
 - Classic negra - Pizarras 164
 - Clean - Sacapuntas 91
 - Clean Grip - Sacapuntas 90
 - Clips 236-237
 - Color'Peps - Lápices de colores 41-53
 - Color'Peps - Rotuladores para colorear 34-39
 - Color'Peps - Sacapuntas 92
 - Compact cut - Guillotina 231
 - Compactos - Sacapuntas 82
 - Compases 130-149
 - Compases - Aprendizaje 130-133
 - Compases - Bigoteras 146
 - Compases - Escolares 134-142
 - Compases - Math sets 147-149
 - Compases - Técnicas 143-145
- Connect - Sacapuntas** 94
- Croc Croc - Sacapuntas** 87-90
- Croc Croc Hipo - Sacapuntas** 87
- Croc Croc Maleable - Gomas** 102
- Croc Croc Puzzle - Gomas** 103
- Croc Croc regla plegable - Trazado** 113
- Cuchillas - Cúteres** 230
- Cuchillas - Oficina y enmarcado** 242
- Cúteres accesorios** 230
- D**
- Dark - Bolígrafos 185
 - Deco - Lápices de grafito 174
 - Dessin - Gomas 105
 - Diamond - Tijeras 228
 - Diseño - Gomas 102-105
 - Distribuidor de cinta adhesiva 234
 - Distribuidor de clip 234
 - Duo Sacapuntas/Goma 93-94
 - Duo-Gom - Gomas 106
- E**
- Easy - Grapadoras 208
 - Easy - Perforadores 220
 - Elements - Sacapuntas 81
 - Epure - Gomas 100
 - Ergo Fun - Gomas 104
 - Ergologic - Grapadoras 207-208
 - Ergologic - Lupas 232
 - Ergologic - Perforadores 217
 - Escalas de reducción - Trazado 130
 - Escarpelos - Oficina y enmarcado 241
 - Escuadra Geo-Flex - Trazado 128
 - Escuadras Technic Geo - Trazado 128
 - Especiales - Lupas 233
 - Essentials - Math Sets 147
 - Essentials - Tijeras 152
 - Essentials Desk - Grapadora 199
 - Essentials Green - Complementos de oficina 234
 - Essentials Green - Perforadores 213
 - Essentials Green - Tijeras 221
 - Essentials Green - Tijeras - Office Colours 196
 - Essentials Metal - Grapadora - Office Colours 195
 - Essentials Metal - Grapadoras 200-202
 - Essentials Metal - Perforador - Office Colours 196
 - Essentials Metal - Perforadores 214-215
 - Essentials Metal - Pinzas grapadoras 202
 - Essentials Soft - Gomas 104-105
 - Essentials Soft - Tijeras 152
 - Estuche de mina - Portaminas 177
 - Estuche para colorear - Rotuladores para colorear 35
 - Estuches 73-78
 - Estuches de neopreno 76
 - Exam pack - Estuches 78
 - Expert - Cúteres 230
 - Expert - Grapadoras 209-210
 - Expert - Perforadores 220
 - Expert - Pinzas grapadoras 209-210
 - Expert - Tijeras 226
 - Expositor - Actividades para colorear 72
 - Expositor - Color'peps Best Sellers 53
 - Expositor - Color'peps Strong/Ocean 53
 - Expositores 245-254
 - Expositores - Pastel 95
- F**
- Fechador 235
 - Flautas de plástico 159
 - Fluo - Lápices de colores 49
 - Fluo Peps - Subrayadores 188-193
 - Fluo Peps Classic Pastel - Subrayadores 190
 - Fluo Peps Duo - Subrayadores 191
 - Fluo Peps Flex - Subrayadores 188
 - Fluo Peps Flex Pastel - Subrayadores 188
 - Fluo Peps Glitter Metal - Subrayadores 167
- Fluo Peps Glitter Pastel - Subrayadores** 167
- Fluo Peps Roller - Subrayadores** 193
- Fluo Peps Surtidos - Subrayadores** 190
- Fluo Peps Ultra Soft - Subrayadores** 193
- G**
- Galactic - Sacapuntas 92
 - Gama 1ª Edad - Línea primera edad 30-33
 - Gel - Cera de colores 63
 - Geometric - Trazado 111-113
 - Glitter Reload 167
 - Globe - Sacapuntas 87
 - Gom-Pen - Gomas 107
 - Gomas 96-107
 - Gomas elásticas 240
 - Grapadoras 197-210
 - Grapas 211-212
 - Graph'Mania - Rotuladores de punta fina 183
 - Graph'Peps - Rotuladores de punta fina 180-183
 - Graph'Peps Compact - Rotuladores de punta fina 183
 - Graph'Peps Deco - Rotuladores de punta fina 180-181
 - Graph'Peps Deco - Rotuladores medium 179
 - Graph'Peps Duo - Rotuladores de punta fina 183
 - Graphic - Compases 131
 - Greenlogic - Gomas 99
 - Greenlogic - Grapadoras 198-199
 - Greenlogic - Perforadores 213
 - Guillotinas 231
- H**
- Herramienta 2 en 1: regla + escuadra 127
 - Herramientas de corte - Oficina y enmarcado 241
- I**
- Igloo - Sacapuntas 83-84
 - Imanes 239
 - Ingeniosos - Sacapuntas 90-92
 - Irrompible - Pizarras 160
 - Irrompible - Trazado 122-125
 - Jungle - Rotuladores para colorear 35-37
 - Jungle Innovation - Rotuladores para colorear 37
- K**
- Kid'z - Compases 131-132, 147
 - Kid'z - Math Sets 147
 - Kid'z 360 - Compases 132
 - KidiCraft - Tijeras 150
 - KidiCut - Tijeras 150
 - KidiPulse - Tijeras 150
 - KidyBoard - Pizarras 159
 - KidyGrip - Trazado 114
 - Kit de coloreado brillante - Mini-Artistas 64
 - Kit de coloreado de 100 piezas - Mini-Artistas 64
 - Kits - Oficina y enmarcado 242
 - Koopy - Tijeras 151
- L**
- Lámina individual de plástico para colorear 72
 - Lápices de colores - Animals 52-53
 - Lápices de colores - Color'peps 41-53
 - Lápices de colores - Fluo 49
 - Lápices de colores - Gama 1ª Edad 31
 - Lápices de colores - Gama adultos 54
 - Lápices de colores - Gama escuela 54
 - Lápices de Colores - Infinity 41-42
 - Lápices de colores - Lápices decorados 51-53
 - Lápices de colores - Mini 49
 - Lápices de colores - Monster 51
 - Lápices de Colores - Oops - Mini-Artistas 58
 - Lápices de colores - Pastel 49
 - Lápices de colores - Star 47-51
 - Lápices de Colores - Strong 43-46
 - Lápices de colores - World 49
 - Lápices de colores Aqua - Mini-Artistas 60

Lápices de colores Duo - Mini-Artistas 59
 Lápices de corrección 177
 Lápices de grafito 168-179
 Lápices decorados - Lápices de colores 51-53
 Lápices Twist - Mini-Artistas 61
 Libro de dibujos para colorear 70
 Línea - Oficina y enmarcado 243
 Little Monster - Gomas 104
 Long Life - Portaminas 178
 Long Life - Rotuladores para colorear 34-35
 Long Life Innovation - Rotuladores para colorear 34
 Loopy - Sacapuntas 93
 Lupa de bolsillo 233
 Lupa regleta 233
 Lupas - Ergologic 232
 Lupas - Especiales 233

M
 Maletín - Gama 1ª Edad 33
 Mantel individuales para colorear 69
 Mapa de Francia - Trazado 129
 Marcadores borrables en seco - Pizarras 163
 Marcadores de tiza - Pizarras 162
 Marcadores Permanentes 193-194
 Marcadores permanentes - Clásico 193
 Marcadores permanentes - Jumbo 194
 Math sets - Compases 147-149
 Metal box - Lápices de colores 51
 Metal Open - Compases 138-139, 149
 Metal Open - Math Sets 149
 Mie de Pain - Gomas 106
 Minas - Compases 145
 Mini - Lápices de colores 49
 Mini Cute 14-19
 Mini juegos para colorear 71
 Mini-Artistas 55-64
 N°308/N°415/N°421 Compases Técnicas 143

N
 Nightfall 20-27
 Normographe - Trazado 129

O
 Ocean - Rotuladores para colorear 38-39
 Oil Pastels - Cera de colores 63
 Origin - Compases 141-142

P
 Paleta de pintura - Pintura 67
 Papeles de colorear con decoraciones metalizadas 67
 Papeles mágicos con efectos para colorear 70
 Papeles para pintar con pastillas de pintura 68
 Pastel 28-29
 Pastillas - Pintura 66
 Pegamento con purpurina - Mini-Artistas 61
 Perforadoras 213-220
 Perforadoras compactas 213
 Piedra Natural - Pizarras 164
 Pinceles - Pintura 66
 Pincha notas 235
 Pintura 65-66
 Pintura - Botellas 65
 Pintura - Gama 1ª Edad 33
 Pintura - Tubos 65
 Pintura con el dedo - Gama 1ª Edad 33
 Pintura mágica 71
 Pinzas clip 236
 Pizarras 159-164
 Pizarras blancas 160-161
 Pizarras negras 164
 Plantilla de letras - Trazado 129
 Plasticlean - Cera de colores 62
 Plumas estilográficas y roller 185-187
 PLV 254-255
 Porta accesorios 234

Postales para colorear 70
 Pratica 35 - Oficina y enmarcado 244
 Precise - Tijeras 155
 Precise Cut - Guillotinas 231
 Precision - Gomas 101
 Precision System - Compases 146
 Premium - Compases 146
 Profila - Oficina y enmarcado 243
 Protección - Gomas 101-102
 Pulse - Compases 130, 147
 Pulse - Gomas 98
 Pulse - Sacapuntas 86
 Pulse - Tijeras 155
 Punchito - Perforadores 213

Q
 Quadra - Oficina y enmarcado 244
 Quita-grapas 212

R
 Reglas - Oficina y enmarcado 243-244
 Regletas 128, 244
 Reload - Bolígrafos recargables 186-187
 Rembrandt - Gomas 106
 Rotuladores Animals 37
 Rotuladores borrables en seco - Pizarras 161-163
 Rotuladores Brush - Mini-Artistas 57
 Rotuladores de punta fina - Graph'Peps 180-183
 Rotuladores Duo Colors - Mini-Artistas 56
 Rotuladores Duo Stamp - Mini-Artistas 55
 Rotuladores Duo Tip - Mini-Artistas 56
 Rotuladores Glitter - Mini-Artistas 56
 Rotuladores Magic - Mini-Artistas 55
 Rotuladores medium 179
 Rotuladores Mini Power - Mini-Artistas 55
 Rotuladores Monster 37
 Rotuladores para colorear - Color'Peps 34-39
 Rotuladores para colorear - Gama 1ª Edad 32
 Rotuladores para colorear - Gama escuela 54
 Rotuladores para colorear - Jungle 35-37
 Rotuladores para colorear - Jungle Innovation 36
 Rotuladores para colorear - Long Life 34-35
 Rotuladores para colorear - Long Life Innovation 34
 Rotuladores para colorear - Mini-Artistas 55-58
 Rotuladores para colorear - Ocean 38-39
 Rotuladores Pastel 37
 Rotuladores Window - Mini-Artistas 58
 Rotuladores XXL Brush Tip - Mini-Artistas 55

S
 Sacapuntas 79-95
 Sacapuntas - Eléctrico 95
 Sacapuntas - Office 95
 Sacapuntas - Sin compartimento de recogida 79-81
 Satellite - Sacapuntas 81
 School pack - Estuches 78
 Security - Tijeras 153
 Sensoft - Tijeras 154, 157
 Sensoft 13 cm - Asimétricas - Tijeras 154
 Shaker - Sacapuntas 84-85
 Shape - Tijeras 156
 Smart box - Lápices de colores 46
 Smiling Planet 8-13
 Softy - Gomas 100
 Soportes para colorear después de montar 68
 Squeeze - Gomas 17, 103
 Star - Lápices de colores 47-51
 Start - Compases 134
 Start - Cúteres 228
 Start - Grapadora 198
 Stop & Safe - Compases 133, 148
 Stop & Safe - Math Sets 148
 Stop System - Compases 139-140
 Stop System Easy - Compases 140-141
 Stop System Innovation - Math Sets 149

Strong - Lápices de Colores 43-46
 Study - Math Sets 148
 Study - Compases 135-137, 148
 Study Stop - Compases 136, 148
 Study Stop - Math Sets 148
 Study Unbreakable - Trazado 119-122
 Subrayadores - Fluo Peps 188-193
 Subrayadores - Fluo Peps Duo 191
 Subrayadores - Fluo Peps Flex 188
 Subrayadores - Fluo Peps Flex Pastel 188
 Subrayadores - Fluo Peps Glitter Metal 167
 Subrayadores - Fluo Peps Glitter Pastel 167
 Subrayadores - Fluo Peps Pastel 190
 Subrayadores - Fluo Peps Roller 193
 Subrayadores - Fluo Peps Ultra Soft 193
 Subrayadores - Surtidos 190

T
 Technic - Gomas 96-99
 Technic Compact - Compases 144-145
 Technic Ultra - Gomas 96
 Technic Ultra Protección - Gomas 101
 Tijeras 150-158
 Tijeras - Aprendizaje 150-155
 Tijeras - Cortes creativos 158
 Tijeras - Escolares 152-154
 Tijeras - Estudiante 155-157
 Tijeras - Oficina 221-228
 Titanium - Tijeras 227
 Tizas - Pizarras 164
 Tizas para aceras - Mini-Artistas 61
 Tonic Metal - Sacapuntas 85-86
 Trazado 108-130
 Trazado - Especiales 127-130
 Trazador de círculos - Trazado 129
 Tubo metálico - Lápices de colores Strong 46
 Tubos - Pintura 65
 Turbo Twist - Sacapuntas 95
 Twin Tip 4 - Bolígrafos 184
 Twis'N Flex - Trazado 115-118
 Twis'N Flex Pulse - Trazado 118

U
 Ultimate - Cúteres 230
 Ultimate - Tijeras 226-227
 Universal - Cizalla 231
 Universal - Grapadoras compactas 203
 Universal - Grapadoras de mesa 204
 Universal - Perforadores 216-217
 Universal - Pinzas grapadoras 204
 Universal Gom Stick - Gomas 107
 Universal plástico - Cúteres 229
 Utensilios para borrar 107

V
 Vertical - Sacapuntas 92
 Visio Pen - Bolígrafos 185
 Vivo - Grapadoras 197
 Vivo - Sacapuntas 79-80
 Vivo - Tijeras 151

W
 Wax - Cera de colores 62

Z
 Zenoa - Gomas 102
 Zenoa Fit - Tijeras 153, 156, 225
 Zenoa Sensitiv - Cúteres 229





A series of horizontal dashed red lines spanning the width of the page, designed for writing notes.

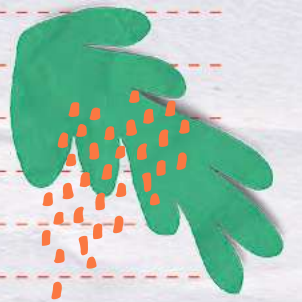

TOMORROW is IN
YOUR HANDS



MAPED SAS - 530 route de Pringy
B.P. 14 - 74370 ARGONAY - FRANCE
Tel. +33 (0)4 50 27 26 85

www.maped.com

